

Jeff Cyr, Chair
Nicole Casolari, Vice Chair
Carol Constant, Clerk
Andrea Miles
Renee Sweeney

Lisa Wong
Town Administrator

HYBRID SELECTBOARD MEETING AGENDA

TUESDAY, JAN. 6, 2026 - 7 P.M.

SOUTH HADLEY SENIOR CENTER MULTI-PURPOSE ROOM

Join Zoom Webinar from your computer: <https://us02web.zoom.us/j/81169576156?pwd=2gAJvXErijygb3lqTb54FErhQtP67Q.1>

By phone: +1 646 558 8656 | Webinar ID: 811 6957 6156 | Passcode: 059386

Watch live on SHCTV Channel 15 or <https://shctv15.com/watch-live/>

Note: Not all topics listed here may be reached for discussion. In addition, the topics listed are those which the chair reasonably expects will be discussed as of the date of this notice. This meeting may be audio and/or visually recorded.

1. **CALL TO ORDER**
2. **ANNOUNCEMENTS / PUBLIC COMMENT**
3. **APPROVAL OF MINUTES**
Draft Minutes of Dec. 16, 2025

Documents:

[DRAFT DEC 16, 2025 SELECTBOARD MEETING MINUTES.PDF](#)

4. **NEW BUSINESS**
 - A. FY27 Budget Notice and Contract Signatory Authorization Highway Bids
 - B. Comprehensive Wastewater Management Plan presentation
 - C. Ledges Rates
 - D. Agricultural Bylaws Advisory Committee
 - E. Citizen Petition – SHELD facility
 - F. 27 Fulton Street Sale

Documents:

[A. FY27 BUDGET NOTICE AND CONTRACT SIGNATORY AUTHORIZATION HIGHWAY.PDF](#)
[A. HIGHWAY-BIDS-PROCESS-GRAPHIC-FY27.PDF](#)
[B. DRAFT COMPREHENSIVE WASTEWATER MANAGEMENT PLAN.PDF](#)
[B. BETA GROUP, INC. - SOUTH HADLEY, MA - CWMP MEETING 2 SR.PDF](#)
[C. THE LEDGES OPERATIONS REPORT 2025_12.PDF](#)
[D. MEMO AG BYLAW.PDF](#)

5. **BUDGET TASK FORCE – PUBLIC COMMENT PERIOD**
6. **RESIGNATIONS**
 - A. Alexander W Hunter – Historical Commission
7. **ADJOURN**

SELECTBOARD MEETING MINUTES
DEC. 16, 2025 – 7 P.M.
HYRBID ON ZOOM AND SOUTH HADLEY SENIOR CENTER

Present in person were Chair Jeff Cyr, Clerk Carol Constant, member Renee Sweeney and Assistant Town Administrator Chuck Romboletti. Member Andrea Miles was present virtually. Vice Chair Nicole Casolari and Town Administrator Lisa Wong were absent.

CALL TO ORDER

Cyr called to meeting to order at 7 p.m.

ANNOUNCEMENTS / PUBLIC COMMENT

Sweeney encouraged folks to take the Budget Task Force Survey on the town website. Constant let residents know they could take out nomination papers to run for office. Miles announced she will not seek re-election and encouraged residents to take out nomination papers for her seat and others.

BUDGET TASK FORCE PUBLIC COMMENT PERIOD

Members discussed the Dec. 8 public listening session and said excellent feedback was received. The next listening session is Jan. 15 at the Senior Center at 1 p.m. and again on Jan. 22 at 6 p.m. Residents are encouraged to take the Budget Task Force survey online on the town website. Hard copies are also available at the senior center, library and town clerk's office.

APPROVAL OF MINUTES

Constant motioned to approve the draft minutes of Dec. 2, 2025. Sweeney seconded.

Roll Call Vote

- Miles – Aye
- Sweeney – Aye
- Constant – Aye
- Cyr – Aye

All in favor. Unanimous.

180 WILLIMANSETT CLASS 2 USED CAR LICENSE

Sweeney motioned to approve a Class 2 Used Car License for Diamond Tools & Equipment Inc dba Diamond Automotive displaying up to 12 secondhand vehicles, at 180 Willimansett Street. Constant seconded.

Roll Call Vote

- Miles – Aye
- Sweeney – Aye
- Constant – Aye
- Cyr – Aye

All in favor. Unanimous.

ANNUAL LICENSE RENEWALS

Miles motioned to approve the 2026 license renewals as publicly presented in the Dec. 16, 2025 Selectboard packet and allow renewal upon completion of all applications, submittal of all fees, completing all required inspections, and any other laws, bylaws or regulations required for issuance. Constant seconded.

Roll Call Vote

- Miles – Aye
- Sweeney – Aye
- Constant – Aye
- Cyr – Aye

All in favor. Unanimous.

TIGHE & BOND POST CLOSURE CONTRACT

Constant motioned to approve the contract with Tighe & Bond for landfill post closure services as presented and allow the Town Administrator to sign on the Selectboard's behalf. Sweeney seconded.

Roll Call Vote

- Miles – Aye
- Sweeney – Aye
- Constant – Aye
- Cyr – Aye

All in favor. Unanimous.

MUNICIPAL HEALTH INSURANCE

The main issue is unsustainable increases in insurance premiums charged to member units and their employees, due to increased claims costs driven by higher-than-average utilization and increased expenses on both medical and pharmaceutical. Romboletti said the next Hampshire County Group Insurance Trust meeting will be held on Dec. 17. A third-party look at the trust will include assessing claims data, reviewing contracts and identifying spending trends. This helps municipalities optimize health plan performance and allocate funds more efficiently. Trust members are hopeful for enhanced communication and transparency.

AFFORDABLE HOUSING UPDATES

Clover Apartments has approximately 20 percent of the project constructed. Substantial completion is slated for Dec. 11, 2026 with an estimated certificate of occupancy on Dec. 28, 2026.

Romboletti provided a clarification about the project's valuation that was brought up at the Nov. 18, 2025 Selectboard meeting. He said Assistant Assessor Melissa Couture Rimbold requested information from Wayfinders and their attorneys will not provide it until at least the spring. Based on these items, the town cannot project an estimate. He thanked Rimbold for her work.

Cyr said he is hoping fees for sewer tie-ins are being paid and asked for an update on that.

REPORTS

Cyr said the Mosier Elementary School Building Committee is meeting tomorrow to further discuss the seven options presented to the committee and public. Cyr will provide another update to the Selectboard at its next meeting. Visit the building committee's website (<https://www.southhadleyschools.org/our-schools/south-hadley-elementary-building-project/home>) or the South Hadley Cable Studio website (<https://shctv15.com/>) for more information.

Constant said the Affordable Housing Trust had its first meeting last week. The trust will apply for a grant to receive assistance in planning for how to use funding.

For the full Town Administrator's Report, see the Dec. 16, 2025 Selectboard packet on the town website.

ADJOURN

Sweeney motioned to adjourn. Miles seconded.

Roll Call Vote

- Miles – Aye
- Sweeney – Aye
- Constant – Aye
- Cyr – Aye

All in favor. Unanimous. The meeting adjourned at 7:30 p.m.

**Respectfully submitted,
Kristin Maher
Executive Assistant to Administration**



Franklin Regional Council of Governments

TO: Collective Highway Bid Participants

FROM: Laura Phelps, Chief Procurement Officer
(ph 413-774-3167 x104)
Email lphelps@frcog.org

RE: FY27 Budget Notice and Signatory Authorization Form

DATE: December 15, 2025

In order to consolidate the collection of information requiring Select Board / Awarding Authority review and approval, we are providing the following details for the upcoming round of Collective Highway bids.

FY 2027 Fee Structure

To assist with each municipalities' budget planning, please use the following figure for the structure of fees that will apply to the Collective Highway Bid program for FY27. (This is the projected fee schedule for FY27, which represents an approximate 5% increase).

Town Population	Fee for FRCOG Member	Fee for Non-FRCOG Member
<500	\$1,212	\$1,433
>500 but < 1,000	\$1,984	\$2,178
>1,000 but < 5,000	\$3,144	\$3,585
>5,000 but < 20,000	\$3,417	\$3,858

(FRCOG member means municipalities in Franklin County who are all members of FRCOG and already pay assessments for FRCOG's other services.)

FY 2027 Contract Signatory

As we begin the FY27 FRCOG Collective Highway Bid process, requesting approvals and identifying key signatures is an important first step. As a reminder, we use the **DocuSign** process for contract execution.

To identify the Authorized Contract Signatory for FY27 Construction Services bids, and Permission to Contract on each Participant's behalf, please carefully review the information on page 2, then complete and return scan **pages 3 & 4** to Laura Phelps at lphelp@frcog.org no later than **January 9, 2026**.

RE: (1) CONSTRUCTION SERVICES BIDS - CONTRACT SIGNATORY AUTHORIZATION

(2) MATERIALS BIDS - PERMISSION TO CONTRACT ON THE PARTICIPANT'S BEHALF

We are beginning the FY27 FRCOG Collective Highway Bid process. Thank you for your continued participation in this program.

Each Municipality must electronically co-sign the Highway contracts for Construction Services bids that they have chosen to participate in via **Docu-Sign**. Prior years' contracts and bid specifications are available to you for review before you sign on. They can be found at frcog.org/bids or by email request.

With your Permission, FRCOG will continue to execute the vendor contracts for Materials bids on your behalf. Reference the full list of Construction Services and Materials bids on page 5.

This process requires the following two steps:

- 1) Signed approval from your Awarding Authority (the Selectboard / Mayor's office), to name the **Authorized Contract Signatory** for the Construction Services bids for which you will be participating in and,
- 2) Acknowledgement that FRCOG may **Contract on Your Behalf** for the Materials bids.

This authorization will cover other bids you may choose to participate in during the next year including Winter Sand, Salt and Liquid, Water Treatment Chemicals, and Equipment Rental bids which will be issued throughout FY27. This does not commit you to participate in those bids or award any particular bid.

*****PLEASE DO NOT DISREGARD THIS REQUEST.***
YOU MUST PROVIDE THE CONTRACT SIGNATORY INFORMATION TO RECEIVE
A FY27 HIGHWAY ESTIMATE SURVEY.**

The signatory may be changed later if someone leaves a position or is not re-elected.

Please scan and return Pages 3 and 4 to lphelps@frcog.org by January 9, 2026.

TO: Laura Phelps, Chief Procurement Officer
FRCOG, 12 Olive Street, Suite 2, Greenfield, MA 01301

We understand that our municipality is participating in the **Franklin Regional Council of Governments Collective Highway Products and Services** Bids and Contracts for FY 2027.

CONSTRUCTION SERVICES BIDS: (please print clearly)

We authorize NAME: _____ whose title is _____ for the City/Town of _____ and whose direct email address* is _____ and telephone number is _____ as the official signatory for all highway construction services contracts in which we choose to participate. We understand that contract execution will be managed through **DOCU-SIGN** and that we will be responsible for electronically signing the contracts in a timely manner. Each participant/signatory must sign before the contract is considered Executed and no work can begin until all Participants have signed.

We understand that we will have the opportunity to preview the Contract Templates for Highway Construction for FY27, each Invitation for Bids with Specifications, and applicable Prevailing Wage Schedules at the FRCOG website at frcog.org/bids and any issues or questions about the form of contract were presented to FRCOG before the Bid Opening which is currently anticipated to be on Thursday, May 7, 2026.

***Note, Docu-Sign cannot accommodate a shared email address – it must be specific to the signatory.**

MATERIALS/GOODS BIDS:

We authorize the Franklin Regional Council of Governments (FRCOG) to contract or renew contracts on our behalf and we have taken action to duly appoint the FRCOG as our agent for Materials bids which include Aggregates and Loam, Cold Patch, Geotextiles, Calcium Chloride Products, Culvert and Guardrail Products, and Hot Mix Asphalt Picked Up.

We acknowledge that FRCOG takes precautions to ensure that procured vendors or contractors have adequate insurance coverage as required by law. Nevertheless, in the event that any vendor or contractor is deemed to be an employee of our city/town for the purposes of Massachusetts Workers Compensation laws, as set forth in Massachusetts General Law (M.G.L.) c. 152, or lapses in their liability coverage, we agree to indemnify and hold harmless FRCOG from any and all claims, liabilities, assessments, costs (inclusive of attorneys' fees and costs of litigation), penalties, judgments, and awards which may be assessed against us.

We agree to abide by M.G.L. c. 30b and c. 30, §39M for the purposes of procuring additional highway products and services, and will not engage in any activity in violation of Massachusetts ethics laws.

Municipalities may not concurrently contract for the same service from multiple collectives (i.e. BRPC, state OSD contracts). A choice must be made before executing the contract.

All financial obligations to vendors and contractors as a result of these agreements are the full responsibility of our city/town and not the FRCOG.

SELECTBOARD / MAYOR OF THE TOWN / CITY OF: _____

Signature

Date

IF REQUIRED:

Signature

Signature

Signature

Signature

Please return pages 3 and 4 of this form by January 9, 2026

You may scan/email to lphehelps@frcog.org

THANK YOU!

A list of the Collective Highway Bids by number is attached. For reference, more information can be found on our website at frcog.org/bids

Type of Material or Service:

Materials

H1 Aggregates and Loam
H2 High Performance Cold Patch
H3 Geotextiles
H4 Calcium Chloride Product
H5 Culvert Products
H6 Guard Rail Products
H7 Hot Mix Asphalt (FOB) Picked Up

W-1 Winter Sand
W-2 Winter Salt and Treated Winter Salt
W-3 Winter Liquid Pretreatment

Services

H9A Highway Line Painting-Ch 90
H9B Highway Line Painting –Rubber - Maintenance / Not Ch 90
H10 Guard Rail Installed
H11A Road Crack Sealing
H11B Microsurface, Fog Seal & Cape Seal Applied
H11C Hot Poured Mastic and Cold Crack Fill
H12 Calcium Chloride Applied
H13 Stone Seal Applied
H14 Rubberized Chip Seal Applied
H15A Hot Mix Asphalt Applied – Roadways
H15B Hot Mix Asphalt Applied – Parking Lots, Driveways, Playgrounds
H15C Leveling and Shim Course *NEW*
H16 Liquid Asphalt Applied
H17 Asphalt Reclamation
H18 Bonded Wearing Course Applied
H19 Hot in Place Recycling
H20 Cold Planing and Milling
H21 Cold In Place Recycling
H22 Tree Work
H23 Catch Basin Cleaning

Participation Fee and Contract Signing Authority given include:

- Highway Equipment and Operator Rental Contract
- Water Treatment Chemicals

Highway Bid Procurement Process Timeline for FY27

This graphic highlights some important tasks and timing for the Collective Summer Highway Products and Services Annual Bid Program. The timeline is tight, and we hope seeing the bigger picture helps you understand the constraints under which the highway bids procurement process occurs. This is a snapshot; our full list comprises close to 80 individual steps and tasks. Your Town's timely responses are VITAL! Any one Town that is late holds up the process for all!

Task:

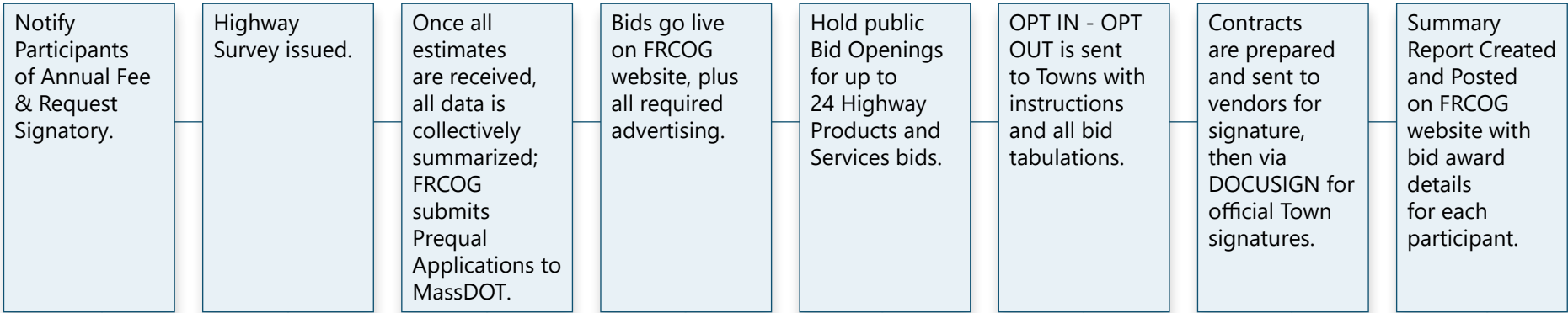

Timing:

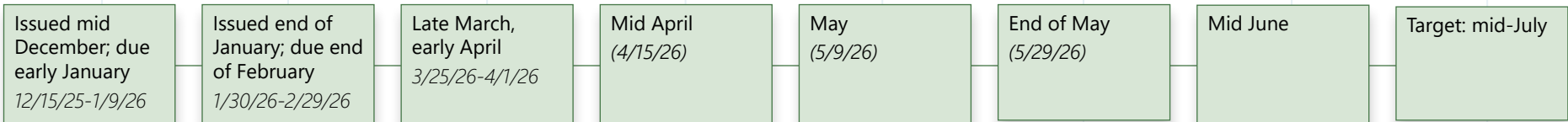

Notes:

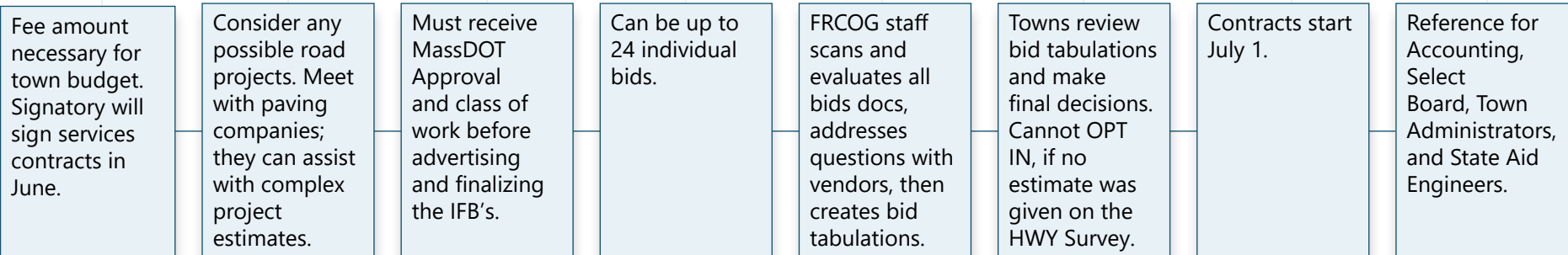

South Hadley, Massachusetts
Comprehensive Wastewater Management Plan

December 2025

DRAFT

Prepared by:



BETA

701 George Washington Hwy
Lincoln, Rhode Island 02865
401.333.2382
www.BETA-Inc.com

TABLE OF CONTENTS

	Page No.
1.0 Executive Summary.....	1
2.0 Existing Conditions & Needs Evaluation	7
2.1 Planning Area	7
2.1.1 General Community Information.....	7
2.1.2 Demographic Profile.....	7
2.1.3 Zoning and Land Use	7
2.1.4 Protected Open Space	9
2.1.5 Water Supply and Water Consumption.....	9
2.1.6 Historic Areas.....	9
2.1.7 Geology, Topography, and Soils.....	14
2.1.8 Floodplains and Wetlands	14
2.2 On-Site Wastewater Disposal Systems (Title 5)	16
3.0 Wastewater Collection System Evaluation	19
3.1 Historical Context.....	19
3.2 Interceptor Sewers	19
3.3 Bypasses and Combined Sewer Overflows (CSOs).....	21
3.4 Infiltration and Inflow (I/I) Reduction.....	22
3.5 Pumping Stations.....	27
4.0 Wastewater Treatment Plant Evaluation.....	38
4.1 Discharge Permit	38
4.2 Treatment Plant Flows & Loads	40
4.2.1 Existing Wastewater Flows	40
4.2.2 Intermunicipal Agreements	43
4.2.3 Infiltration and Inflow (I/I) Analysis.....	43
4.2.4 Existing Pollutant Loading.....	44
4.3 Liquid Treatment Process	46
4.3.1 Preliminary Treatment System	47
4.3.2 Primary Treatment System	48
4.3.3 Biological Treatment System	52
4.3.4 Disinfection System	55
4.4 Solids Handling	58
4.4.1 Ventilation and Odor Control.....	59

4.5 Ancillary Systems..... 61

 4.5.1 Plumbing Systems 61

 4.5.2 Heating Ventilation And Air Conditioning (HVAC)..... 62

 4.5.3 Electrical..... 64

 4.5.4 Instrumentation And Controls 67

5.0 FUTURE CONDITIONS..... 69

 5.1 Population and Demographic Projections 69

 5.2 Future Land Use & Development 69

 5.3 Future Flows and Loads 70

 5.3.1 Flow From Granby 70

 5.3.2 Flow From Chicopee 71

 5.3.3 Flow and Load Projection 71

6.0 Evaluation of Treatment Alternatives – WWTP Upgrades..... 72

 6.1 Discharge Permit and Flow Considerations 72

 6.2 Alternatives to Remove Nitrogen..... 72

 6.2.1 Modified Ludzack Ettinger (MLE) Process..... 72

 6.2.2 Cyclical Nitrogen Removal (Cyclical Aeration) 75

 6.2.3 Separate Stage Denitrification Filters..... 77

 6.3 Alternatives to Improve Disinfection..... 80

 6.3.1 Chlorination/Dechlorination 80

 6.3.2 Ultraviolet Disinfection (Paired with Upstream Filtration) 82

 6.4 Regional Approach – Interconnection with the City of Holyoke..... 83

7.0 Recommended Plan..... 87

 7.1 Recommended Pumping Station Improvements 87

 7.2 Recommended Wastewater Treatment Plant Improvements..... 88

 7.2.1 Recommended Improvements For Permit Compliance 88

 7.2.2 General Process Area Plant Upgrades 89

 7.3 Ancillary Systems..... 90

 7.3.1 Electrical Systems..... 90

 7.3.2 HVAC Systems 91

 7.3.3 Instrumentation and Controls..... 91

 7.3.4 Plumbing Systems 91

 7.3.5 Architectural Improvements..... 92

 7.4 Opinion of Probable Project Cost 92

 7.5 Financial Impact Analysis (TBD)..... 92

7.6 Implementation Schedule..... 95

 7.6.1 Sewer System Expansion 95

 7.6.2 Main Street Pump Station..... 95

 7.6.3 Wastewater Treatment Plant Upgrade 95

 7.6.4 Other Wastewater Pump Stations 96

7.7 Environmental Assessment..... 98

 7.7.1 Mitigation..... 99

7.8 State and Local Permits 102

8.0 Public Participation..... 103

 8.1 Public Meetings..... 103

 8.2 Public Hearing 103

List of Tables

Table 3-1: Wastewater Pumping Stations 27

Table 4-1: Existing NPDES Permit Discharge Limitations (2023 Permit)..... 38

Table 4-2: WWTP Effluent Flows (2021 – 2024)..... 41

Table 4-3: Estimated I/I Rates (Years 2021-2023) 44

Table 4-4: Monthly Average Influent and Effluent BOD Load..... 45

Table 4-5: Monthly Average Influent and Effluent TSS Load 46

Table 4-6: Effluent Nitrogen Loads 46

Table 4-7: Aerated Grit Chamber Data 48

Table 4-8: Primary Clarifier Surface Overflow Rates 51

Table 4-9: Design Data – Secondary Clarifiers 54

Table 4-10: Design Data – Chlorine Contact Chambers 55

Table 4-11: WWTP Effluent TRC and E. coli Summary (2021 – 2024) 57

Table 5-1: Population Projections through 2045 69

Table 5-2: Projected Average Day and Maximum Monthly Flow and Loading Rates 71

Table 6-1: Typical Design Parameters – MLE Process 74

Table 6-2: Opinion of Probable Project Cost – MLE Process 75

Table 6-3: Opinion of Probable Project Cost – Cyclical Aeration 77

Table 6-4: Opinion of Probable Project Cost – Denitrification Filters 80

Table 6-5: Opinion of Probable Project Cost – Chemical Dechlorination 82

Table 6-6: Opinion of Probable Project Cost – Ultraviolet Disinfection 82

Table 7-1: Wastewater Improvement Projects - Summary of Probable Project Cost..... 93

List of Figures

Figure 1: Planning Area..... 8

Figure 2: Zoning..... 10

Figure 3: Protected Open Space 11

Figure 4: Fire Districts 12

Figure 5: Historic Districts..... 13

Figure 6: Soil Mapping 15

Figure 7: FEMA Floodplains 17
Figure 8: Septic Systems 18
Figure 9: South Hadley Sewer System 20
Figure 10: Sewersheds 26
Figure 11: WWTP Site Plan 39
Figure 12: Total Daily WWTP Flow Versus Total Daily Precipitation..... 42
Figure 13: MLE Process Schematic 73
Figure 14: Process Flow Diagram of Separate Stage Denitrification Filters..... 78
Figure 15: Site Plan - Denitrification Filters 79
Figure 16: Dechlorination System Preliminary Layout 81
Figure 17: Preliminary Evaluation – Interconnection with Holyoke 85
Figure 18: Implementation Schedule 97

List of Appendices

- Appendix A: South Hadley NPDES Permit
- Appendix B: Biowin™ Modeling Results
- Appendix C: Materials from Public Meetings

1.0 EXECUTIVE SUMMARY

This report was prepared in accordance with Massachusetts Comprehensive Wastewater Management Planning criteria. It assesses current and future wastewater needs and evaluates wastewater management alternatives to address these needs. The recommended projects in this twenty-year plan were selected through careful comparison and evaluation of various alternatives to ensure that the most cost effective, environmentally sound wastewater management plan is set forth. Approval of this Plan by MassDEP allows for access to state and federal funding programs, such as the Clean Water State Revolving Fund, to finance recommended projects.

This Comprehensive Wastewater Management Plan (CWMP) was prepared with assistance from numerous Town employees including John Broderick, Director of Public Works, Melissa LaBonte, Superintendent of Water Pollution Control and Michael Cijka, Chief Operator of Water Pollution Control.

South Hadley owns and operates extensive wastewater collection and treatment systems that serve more than 95% of the town's population. In addition, small sections of the neighboring communities of Granby and Chicopee also contribute wastewater to the system. By agreement Granby and Chicopee are allowed to discharge 85,000 gallons per day and 150,000 gallons per day, respectively, into the South Hadley system on an average day basis. Neither community exceeds its allowed discharge capacity and nor expressed an interest in increasing its future capacity. The wastewater system includes:

- over 85 miles of pipe including eight siphons;
- 5 wastewater pumping stations; and
- one wastewater treatment plant (WWTP) with a capacity of 4.2 mgd.

The approximate replacement value of the wastewater system is over \$200,000,000. To properly manage an asset of this size, the condition of the wastewater system needs to be periodically reviewed to identify and prioritize repairs, upgrades and equipment replacements. The report that follows will help South Hadley officials understand the condition of the system and plan for future needs and upgrades.

Needs Areas

Approximately 450 properties have their wastewater disposal needs served by on-lot sewage disposal systems. Most of these properties are located in the northern half of the Town and along the banks of the Connecticut River. After speaking with South Hadley's Board of Health regarding areas in Town that experience issues with their on-lot disposal systems, the following list was generated:

- Hadley Street (north of Bachelor Brook)
- Pearl Street
- Amherst Road
- Meadow Lane, Woodbridge Road, Woodbridge Terrace, and Red Ledge Road
- East Street (near the Granby Town line)
- Cove Island and River Road

All of the areas identified above were also identified in the Town's 2001 Comprehensive Wastewater Management Plan. Common problems with septic systems in the noted locations are ledge, high groundwater table and soils with drainage limitations. It should be noted that there are only about 130 homes in these areas. In many cases, the Town's sewer system is present in the area but was not extended to the identified streets due to topographic limitations. Due to the limited number of homes that would be served by sewer extensions, the cost per lot or the betterment assessment, would likely be prohibitive.

Wastewater Collection System

When South Hadley was originally incorporated in 1775, it was divided into two villages; the Falls area located along the Connecticut River, and the Center Area located approximately two miles north of the Falls Area. Sewers in these two areas, which were predominantly combined for both stormwater and wastewater collection, were originally constructed from 1920 to 1950. At one time, the South Hadley sewer system had a total of 16 Combined Sewer Overflows (CSOs) in its system.

Following the completion of the Lower Connecticut River CSO Study in 1988, South Hadley has expended considerable resources repairing its wastewater collection system and separating storm and sanitary sewers. The most recent project completed (2024) was the rehabilitation of the Judd Brook interceptor. Although limited data has been collected, significant reductions in wet-weather flows have been reported. To avoid redundancy, a comprehensive list of projects undertaken can be found in Section 3.4 of this report. These actions have resulted in the effective elimination of the CSOs. However, sections of the collection system, particularly in the Falls area, likely have sources of stormwater inflow that are still connected to the wastewater system.

The Town must continue to perform annual Flow Monitoring Studies within the collection system to identify sources of infiltration and inflow and make the necessary improvements to eliminate extraneous flow sources.

Pump Stations

Five (5) pumping stations, including the Main Street Station, are located within the South Hadley collection system. All wastewater collected within the system is ultimately conveyed to the treatment plant by the Main Street Pump Station. The Main Street station, which is equipped with four pumps rated at 2,900 gpm, was originally constructed in 1978 with some minor improvements made in 2008. In 2023, a thorough evaluation of the station was conducted. Major recommendations from that evaluation included replacing all four pumps, providing flood protection, improving ventilation on both the wet and dry sides of the station, and upgrading the instrumentation and electrical systems. The estimated cost to design and construct the improvements was approximately \$9,500,000.

The Stony Brook Pump Station was last upgraded in 2007-2008 when the station was converted from a pneumatic ejector to a submersible pump station. Two submersible pumps, each rated for 320 GPM at 45-feet of TDH, are located in a wet well outside of the station's enclosure. Although the station is presently in good condition mechanically, toward the latter half of the planning period, pumps, valves, HVAC equipment and the generator will need to be replaced. Concerns that should be addressed sooner are the replacement of the roof, which is damaged, and replacement of the hot water heater, which has passed its useful life expectancy.

The Morgan Street pump station is a small, duplex suction lift station that was constructed in 1991 to replace an older ejector type station. It is recommended that the Morgan Street pump station be converted to a submersible style station to enhance its reliability. In addition, the site requires improved access for pump trucks and other large equipment. The generator also needs to be replaced, and HVAC equipment is nearing the end of its useful life.

The Old Sycamore ejector station is the oldest pump station in Town as it was constructed in the 1960's. Some minor upgrades were completed in the 1990s. Besides the overall age of the station and the mechanical and electrical equipment within, other issues include a leaking suction line, and the lack of

explosion proof equipment, which is a violation of the electrical code. Old Sycamore does not have a standby generator since flow can be directed to an overflow pipe that discharges to the Topors pump station if the station fails. It is recommended that this station be abandoned and that all flow be directed to the Topors pump station on a permanent basis.

The Topors pump station is a small pneumatic ejector station constructed in 1973. With the recommended abandonment of the Old Sycamore pump station, recommended improvements include upgrading the station from an ejector station to a submersible station with adequate pumping capacity to handle flow from the Old Sycamore station, installation of a new emergency generator and transfer switch and upgrading the gravity sewer connecting the Old Sycamore pump station to the Topors pump station.

Wastewater Treatment Plant

The South Hadley WWTP is located on James Street in the City of Chicopee, MA. However, the facility primarily treats wastewater for approximately 95% of South Hadley's residents and small sections of the Town of Granby and the City of Chicopee. The plant was originally constructed in 1960 as a primary treatment facility with anaerobic digestion of biosolids. An upgrade to the facility was constructed in the late 1970s to achieve secondary treatment standards using a conventional activated sludge process. The last upgrade to the WWTP was completed in 2008 with a limited scope of work that included the replacement of four (4) mechanical aerators, other mechanical equipment, and the inclusion of an activated carbon odor control system.

The WWTP is currently designed to treat an average daily flow of 4.2 million gallons per day (mgd) and a peak hourly design flow of 10.74 mgd. It should be noted that the design flows and the treatment processes stated above were established for a conventional activated sludge process providing secondary treatment. They do not account for the new NPDES permit requirement to remove total nitrogen which will increase process oxygen demand and necessitate a change in use of process tanks.

Historical flow data spanning from January 1, 2021 to December 31, 2024 was evaluated to determine current flow rates at the South Hadley WWTP. The average of the 12-month rolling average flow over the study period was 3.05 mgd, which is well below the permitted 12-month rolling average flow of 4.2 mgd. Accordingly, the mass of various pollutants entering the treatment facility are also well below design thresholds. Based on the limited amount of sewers that could be constructed in South Hadley and the lack of any sewer system expansion in Granby and Chicopee, the design flow of the WWTP is adequate throughout the planning period.

The data also demonstrates that flows to the WWTF are impacted by rainfall as maximum daily flows to the WWTP routinely exceed 8 mgd following precipitation events. Monthly flows where substantial rainfall has occurred have also exceeded the average day design capacity of the WWTF. Although the WWTP can handle and treat wastewater during these times, it is worth noting as high inflow rates still impact the collection system.

In terms of performance, the WWTP has not been able to consistently meet its discharge permit limits for total nitrogen (12-month rolling average of 350 pounds per day) and E. coli (126 colonies/100 ml). Although operators maximize the potential of the existing WWTP to remove nitrogen, a process dedicated for this purpose is not incorporated into the facility. Operators also have to balance the dose of sodium hypochlorite to achieve adequate disinfection to comply with the E. coli limit with the chlorine residual

limit in the permit. Local fishermen are averse to exceedances of the chlorine residual limit, which causes operators to limit the sodium hypochlorite dose resulting in the E. coli limit being exceeded.

Recommended WWTP Improvements

To allow the WWTP to consistently meet the total nitrogen limit it was demonstrated that converting the biological treatment process from conventional activated sludge to the Modified Ludzack Ettinger (MLE) process was the most reliable and cost-effective approach. Process improvements will include:

- Conversion of the first basin in each biological treatment train to a dedicated anoxic zone and a swing zone of equal volume. This requires the construction of one wall to divide the basin in half and a second wall to split the dedicated anoxic zone into two passes.
- Installation of submersible mixers in each pass of the anoxic zone and in the swing zone;
- Installation of a fine bubble diffusers in the swing zone and the dedicated aerobic basin;
- Construction of a new enclosure to house blowers and associated electrical controls,
- Installation of three 75 HP positive displacement blowers capable of supplying 1,750 SCFM of air at 6.8 psi;
- Installation of two internal recycle pumps at the end of each aerobic basin. Each pump shall be capable of conveying 1.7 mgd of nitrified effluent back to the first pass in the anoxic zone.
- Installation of instrumentation in the biological reactors to monitor dissolved oxygen and control the amount of air fed to the process for treatment.
- Construction of a chemical storage tank (sodium hydroxide, magnesium hydroxide, sodium carbonate, etc.) and metering pumps.

It was also demonstrated that the installation of measures to chemically dechlorinate the final effluent would be the best means of achieving permit compliance with both the effluent limits for E. coli and Total Chlorine Residual. Implementing means to reduce the concentration of residual chlorine in the discharge will allow sodium hypochlorite to be dosed at higher concentrations into the chlorine contact tanks to achieve more effective reduction of pathogens. Process improvements will include:

- Construction of a prefabricated, heated building to house either a 1,200-gallon bulk storage tank or a 275-gallon totes of sodium bisulfite. The building could be sited in a section of the existing parking lot in proximity to the effluent side of the chlorine contact tanks.
- Installation of pumps to meter bisulfite into the discharge end of the chlorine contact tanks;
- Instrumentation to monitor chlorine residual and/or ORP that will serve to adjust the dose of bisulfite.

Due to the age of the treatment facility, much of the existing equipment and ancillary systems are operating beyond their typical design lives. Upgrades to these facilities are necessary to ensure the long-term reliability of the treatment process. Some of the more significant recommended improvements are presented below:

- The grit chamber has been in operation for over 40 years, and several pieces of equipment are original to the facility. The bucket elevator, grit screw conveyor, and the dewatering screw need to be replaced.
- Replacement of the chain and flight sludge collectors in each of the three primary clarifiers, along with the primary sludge pumps. This equipment was last replaced in 1998. The drives for clarifiers #2 and #3 should be separated to improve redundancy. This process has been initiated.
- Replacement of the secondary clarifier drives, rake arms, and sludge draw-off equipment that were installed in the late 1970s.

- Replacement of the two steel gravity thickeners in the solids handling process. These tanks were installed in the late 1970s and are exhibiting signs of corrosion due to the harsh environment in which they reside. The new gravity thickeners should be covered to reduce the volume of air that needs to be extracted for odor control purposes.
- Replacement of the two plunger type thickened sludge pumps with progressive cavity or other suitable style pumps.
- Replacement of single belt filter press with either two screw presses or two centrifuges. Two units are suggested for process redundancy.
- Although a concern related to HVAC, the air handling and odor control system for the solids handling area and the operations building needs to be completely replaced. Twelve air changes per hour shall be provided in the thickener room and the belt filter press room. The exhaust will be treated for odors. For purposes of this evaluation a chemical scrubber has been incorporated into the project cost.
- Replacement of most of the electrical systems.
- Replacement of HVAC systems throughout the plant.
- Replacement of the SCADA control system which is presently configured with two separate PLC platforms. The system does not have redundant PLC processors should the main PLC processor fail. The remote input/output modules are approaching their useful life and are no longer supported by the manufacturer.
- The buildings at the WWTF were constructed in the late 1970s. Architectural components of the buildings such as windows, doors, and roofs are original to the facility and need to be replaced. Interior sections, particularly the administrative offices, also need to be reconfigured and refreshed with new flooring, ceilings and paint. Bathrooms and locker rooms in the operations building should also be updated.

Financial Impacts

An opinion of probable project cost associated with the recommended improvements is provided in Table ES-1. It is anticipated that most of the proposed work, except for engineering design fees, will be eligible and funded through the state's Clean Water State Revolving Fund (CWSRF). CWSRF loans typically have a payback period of 20 years and carry an interest rate of 2%. However, recommended projects that have a nutrient removal component, such as those at the South Hadley WWTP, are eligible for loans at 0% interest.

In addition, South Hadley is designated by MassDEP as a Tier 2 Disadvantaged Community where the adjustable per capita income is between 60% and 80% of the state average. CWSRF funded projects in a Tier 2 Disadvantaged Community are eligible for 6.6% principal forgiveness.

South Hadley has a Wastewater Enterprise Fund that is the dedicated financial account for the town's sewer system, funding essential operations and maintenance upgrades and small capital projects. The enterprise fund is supported from user fees. The current sewer use fee is \$500 per year per equivalent dwelling unit (EDU), which generates \$4,429,000 of revenue based on the 8,858 EDUs that are presently billed.

To assess financial impacts from the recommended projects, it has been assumed that the Town would apply for and receive funding for construction through the CWSRF program. Pump station construction would be funded at 2% interest over 20-year term while construction of the wastewater treatment facility would be funded at 0% over a 20-year term. Since the Town is designated as a Tier 2 Disadvantaged

Community, principal forgiveness of 6.6% on the construction loans has been factored into financial impact analysis. As shown in Table 7-1, the estimated net total project cost (less principal forgiveness) to improve all of the Town’s pump stations is \$12,210,000. The majority of the work is associated with the Main Street pump station. The estimated total annual cost is \$760,000, or \$86 per EDU. The estimated net total project cost to improve the wastewater treatment facility is \$35,060,000. The estimated total annual cost is \$1,810,000 or \$206 per EDU.

Table ES-1

Item	Construction Cost (\$)
Pumping Stations	
Main Street	7,030,000
Stony Brook	20,000
Morgan Street	900,000
Topors	1,000,000
Old Sycamore	20,000
Subtotal	8,970,000
Engineering Design (10%)	900,000
Engineering During Construction (10%)	900,000
Construction Contingency (25%)	2,240,000
Total Project Cost	13,010,000
Principle Forgiveness	(800,000)
Net Project Cost	12,210,000
Annualized Net Project Cost ¹	760,000
Wastewater Treatment Facility	
Grit Removal	1,150,000
Primary Treatment	1,570,000
Biological Treatment System (including MLE upgrade)	6,190,000
Disinfection Improvements	320,000
Solids Handling	5,600,000
Electrical Systems	5,110,000
HVAC Systems	2,620,000
SCADA System	550,000
Plumbing Systems	700,000
Architectural Improvements	1,200,000
Site Restoration	750,000
Subtotal	25,760,000
Engineering Design (10%)	2,580,000
Engineering During Construction (10%)	2,580,000
Construction Contingency (25%)	6,440,000
Total Project Cost	37,360,000
Principle Forgiveness	(2,300,000)
Net Project Cost	35,060,000
Annualized Net Project Cost ¹	1,810,000
 Additional Annual O&M Cost	 20,000
Total Annual Cost	2,590,000

1. Engineering design cost financed at 4% over 20 years
 Pump station construction costs financed through CWSRF at 2% over 20 years
 Treatment facility construction costs financed through CWSRF at 0% over 20 years.
 Principle forgiveness equal to 6.6 of project cost less engineering design

2.0 EXISTING CONDITIONS & NEEDS EVALUATION

The objective of this chapter is to outline existing conditions within the Town of South Hadley that will influence future development and have a direct impact on wastewater management planning. Development trends are influenced by factors such as the national, regional, and local economy as well as supply and demand pressures. Similarly, the physical environment of the planning area including topographic conditions, presence of natural systems (wetlands, waterbodies, etc.), and soil conditions significantly influence the rate and location of development. Finally, the community's proximity to major economic drivers, regional job centers, transportation networks, and the availability of water and sewage disposal systems can also greatly affect development patterns. This section also provides an overview of the existing wastewater collection and treatment facilities and includes a description of existing wastewater flows within the planning area.

2.1 PLANNING AREA

2.1.1 *GENERAL COMMUNITY INFORMATION*

The Town of South Hadley is located in Hampshire County in the western part of Massachusetts and is positioned between the Connecticut River to the west and the ridgeline and southern slopes of Mount Holyoke Range to the north. Adjacent communities to South Hadley include Amherst (north), Chicopee (south), Granby (east), Hadley (north), and Holyoke (west). Four major brooks/streams drain a majority of the Town to the Connecticut River and include, from north to south; Batchelor Brook, Stony Brook, Judd Brook, and Buttery Brook. A layout of the entire community provided as Figure 1.





The Town of South Hadley was incorporated in 1775 and was historically divided into two main villages: the Falls and the Center. The Falls area in the southern section of the town is densely populated and was originally developed as the commercial and industrial center of the community. The Center is a mainly residential section of the community that was developed around the Mount Holyoke College. The Town occupies approximately 18.4 square miles and has a population of 18,150 according to the 2020 United States Census Bureau.

2.1.2 *DEMOGRAPHIC PROFILE*

Population characteristics play an important role in identifying a community's needs, projecting future growth and development, and determining wastewater generation rates. According to the United States Census Bureau, the 2020 population for the Town of South Hadley was recorded at 18,150, which is a 3.6% increase over the 2010 Census population of 17,514. The Town's Master Plan, which was adopted in March of 2020, predicts the Town's population will increase by 2.5% by the year 2030, which would result in a population of approximately 18,600. These Projected population estimates are lower than those predicted in the 2001 Comprehensive Wastewater Management Plan. The estimated population served by the South Hadley wastewater collection system is 17,300.

2.1.3 *ZONING AND LAND USE*

The Town of South Hadley is divided into twelve zoning districts that are influenced by residential, business, industrial, and agricultural characteristics. Additionally, the Town is comprised of four overlay districts that interact with housing. Wastewater needs in residential areas are mainly served by the municipal wastewater collection system. Approximately 50% of the Town is zoned as Agricultural land, particularly the land located north of Bachelor Brook. A small portion of the Town is comprised of Business

-  Multi-Lane Highway, NOT Limited Access
-  Other Numbered Route
-  Major Road - Arterials and Collectors
-  Minor Street or Road
-  Town Boundary

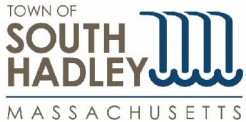
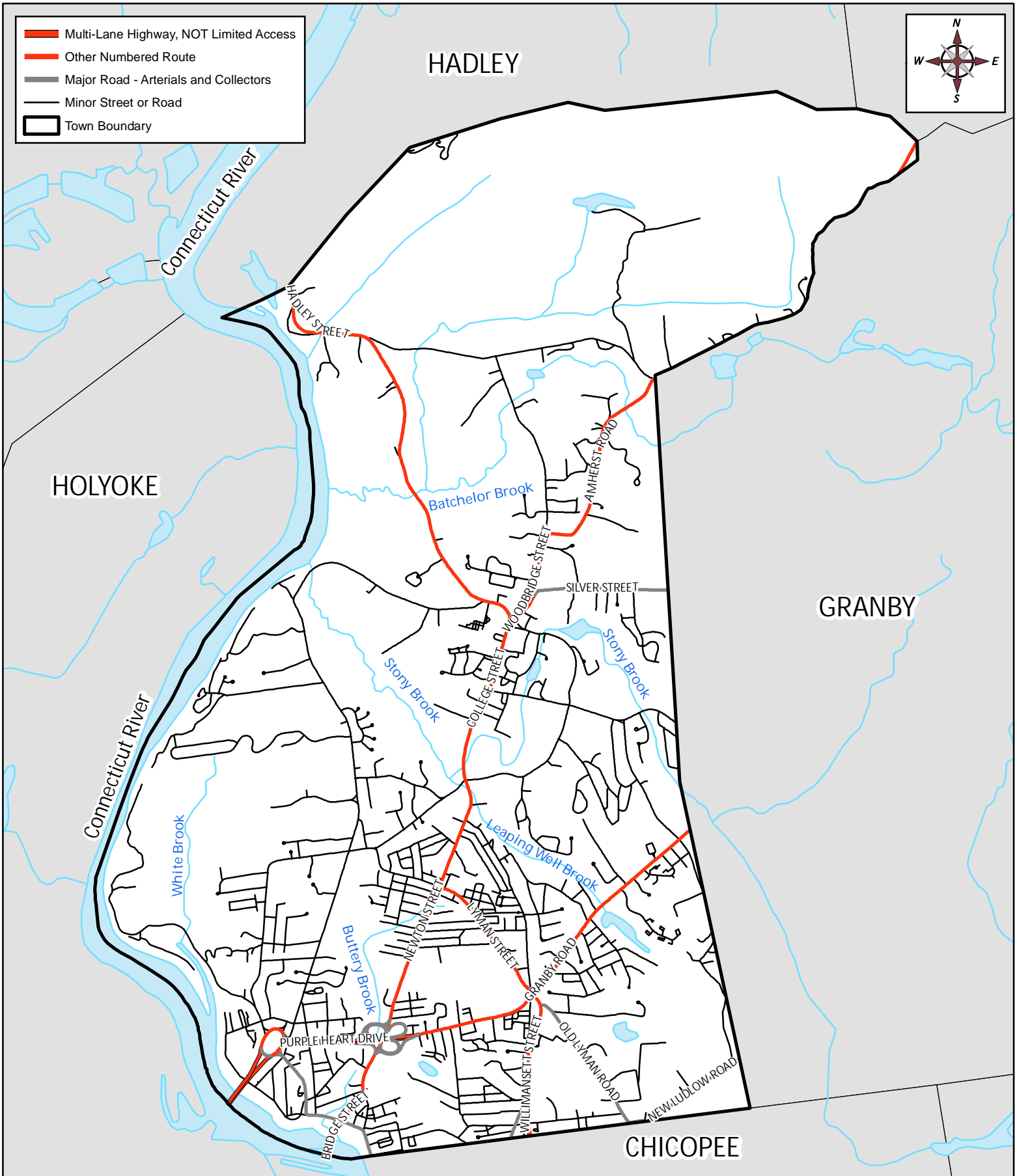
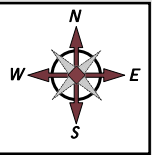

Comprehensive Wastewater Management Plan (2025)

Town of South Hadley, MA

Figure 1
Planning Area

Scale: 1 inch = 4,000 feet
Source: Town of South Hadley GIS

and Industrial Zones that are primarily located in the southern portion of the Town and along the Connecticut River. A map showing zoning within the Town is provided as Figure 2.

2.1.4 PROTECTED OPEN SPACE

A significant portion of the land owned by the Town is preserved for conservation and recreational purposes. These protected areas are managed by either the Conservation Commission or the Recreation Commission. The Conservation Commission owns and manages 1,080 acres, approximately half of the town-owned lands, which are considered protected open space of South Hadley. The Conservation Commission manages approximately 16 distinct Conservation Areas, which help preserve the Town's water quality, wildlife habitat, and recreational resources. Protected open space is shown in Figure 3.

2.1.5 WATER SUPPLY AND WATER CONSUMPTION

South Hadley's potable water supply is provided by two separate water/fire districts. Fire District #1 supplies potable water to approximately 70% of the Town's population, which includes the southern portion of the Town in the Falls area and 260 properties in the towns of Ludlow and Granby. District #1's water supply was derived from the Leaping Well Reservoir and Buttery Brook. This source was abandoned circa 1950 and replaced with water purchased from the Metropolitan District Commission (Quabbin Reservoir). The district continues to own 39.1 acres which includes the Leaping Well Reservoir and several parcels off Bartlett Street.

Fire District #2 supplies potable water to the remainder of the Town, north of the intersection of Brainerd Street, Mosier Street, and Newton Street (Rt. 116). District #2's water supply is provided by the Dry Brooks Wells, an in-town water supply source located between Hadley Street and the Connecticut River. As described in Section 2.1.4 the Water Supply Protection District (WSPD) provides land use protection for watershed areas that supply District #2's water supply. At one time, Fire District #2's primary water supply was provided from the Lithia Springs Reservoir. To protect the reservoir, the district owned over 600 acres of land in the Mount Holyoke Range. In 2004, the Connecticut Department of Conservation and Recreation (DCR) acquired all but 84.7 acres of this land. The two Fire Districts are depicted in Figure 4.

Historical water use records offer a means of estimating wastewater generation rates. Generally, up to 90% of the total water used in a sewered community will enter a wastewater collection system. Uses such as lawn and garden watering, firefighting, and certain manufacturing operations do not contribute to the flow reaching centralized wastewater collection systems. The Consumption History Reports for 2023 from both Fire Districts indicates that the annual metered water consumption within the Town of South Hadley (including 260 properties in Ludlow and Granby) was approximately 453 million gallons, which corresponds to an average daily water consumption rate of 1.24 million gallons. Approximately 98% of the water consumers in South Hadley are serviced by either of the two Fire District systems. Distributing metered water consumption over the estimated population served, which includes approximately 17,900 in South Hadley and approximately 530 in Ludlow and Granby, results in a daily per capita demand of 67.3 gallons. Therefore, the corresponding per capita wastewater contribution is 60.5 gallons.

2.1.6 HISTORIC AREAS

The Town of South Hadley has two significant Historic Districts listed on the National Register of Historic Places: the South Hadley Canal District and the Woodbridge Street Historic District. Additionally, the Town's Historic District Study Committee has proposed establishing a local historic district in a section of South Hadley's Falls area, which is centered around North Main Street. The historic districts, including the proposed district in the Falls area, are depicted in Figure 5.

- Multi-Lane Highway, NOT Limited Access
- Other Numbered Route
- Major Road - Arterials and Collectors
- Minor Street or Road
- Town Boundary

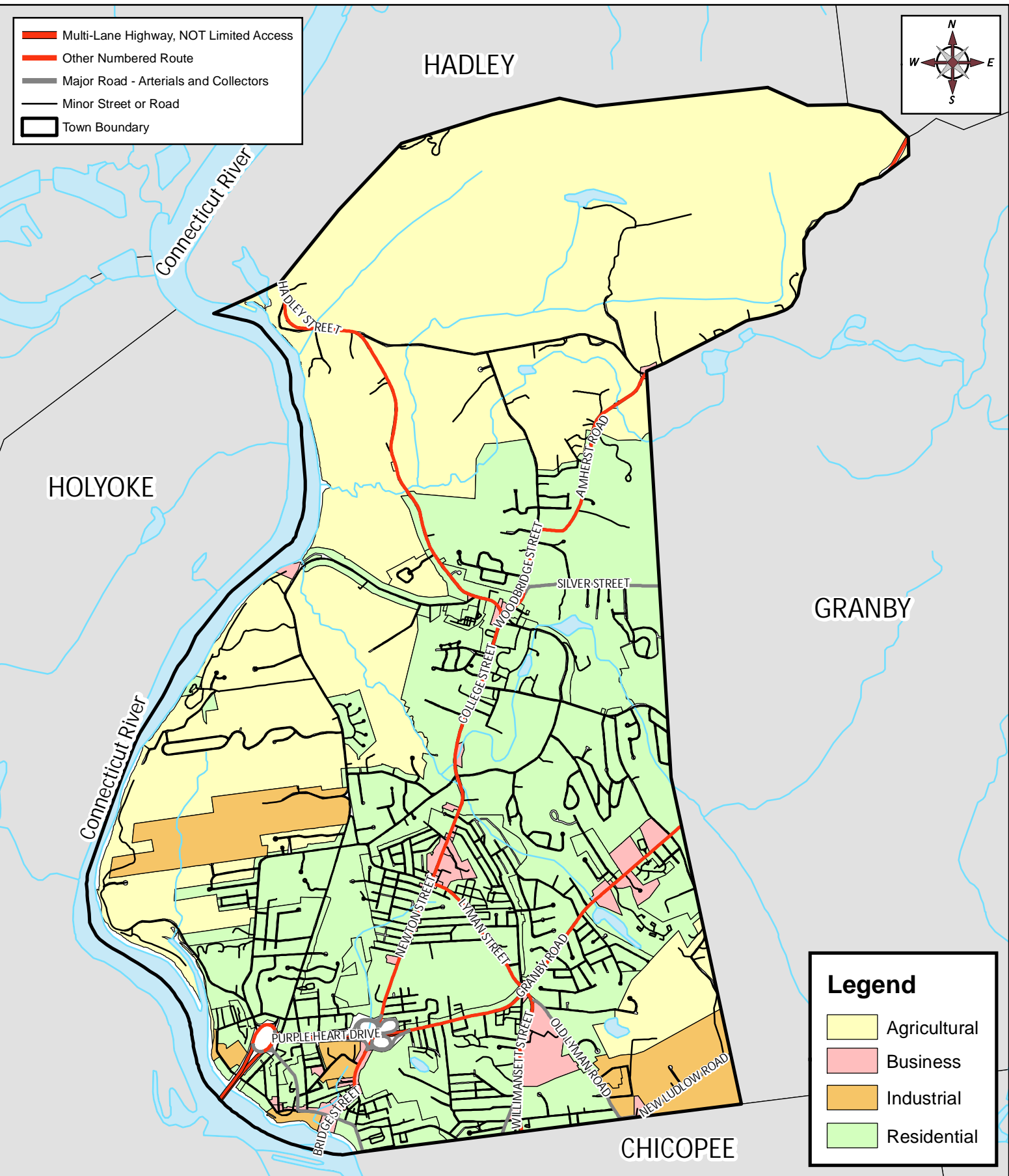
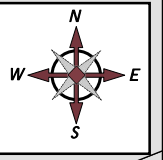

- Legend**
- Agricultural
 - Business
 - Industrial
 - Residential







TOWN OF
SOUTH HADLEY
MASSACHUSETTS

Comprehensive Wastewater
Management Plan (2025)





Town of South Hadley, MA

Figure 2
Zoning

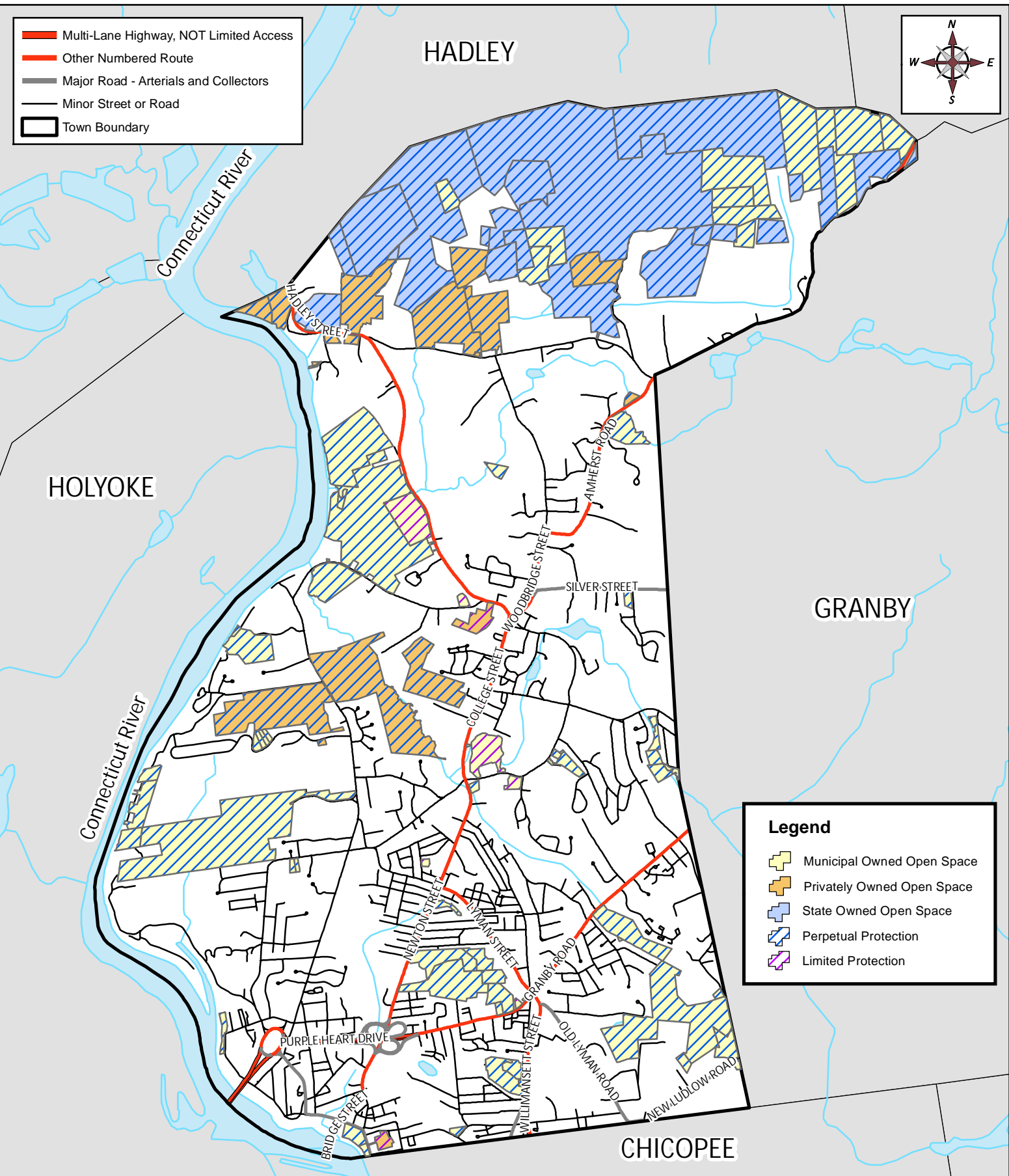
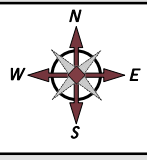
Scale: 1 inch = 4,000 feet
Source: Town of South Hadley GIS

-  Multi-Lane Highway, NOT Limited Access
-  Other Numbered Route
-  Major Road - Arterials and Collectors
-  Minor Street or Road
-  Town Boundary



- Legend**
-  Municipal Owned Open Space
 -  Privately Owned Open Space
 -  State Owned Open Space
 -  Perpetual Protection
 -  Limited Protection







TOWN OF
SOUTH HADLEY
MASSACHUSETTS

Comprehensive Wastewater
Management Plan (2025)

Town of South Hadley, MA



Figure 3
Protected Open Space

Scale: 1 inch = 4,000 feet
Source: Town of South Hadley GIS

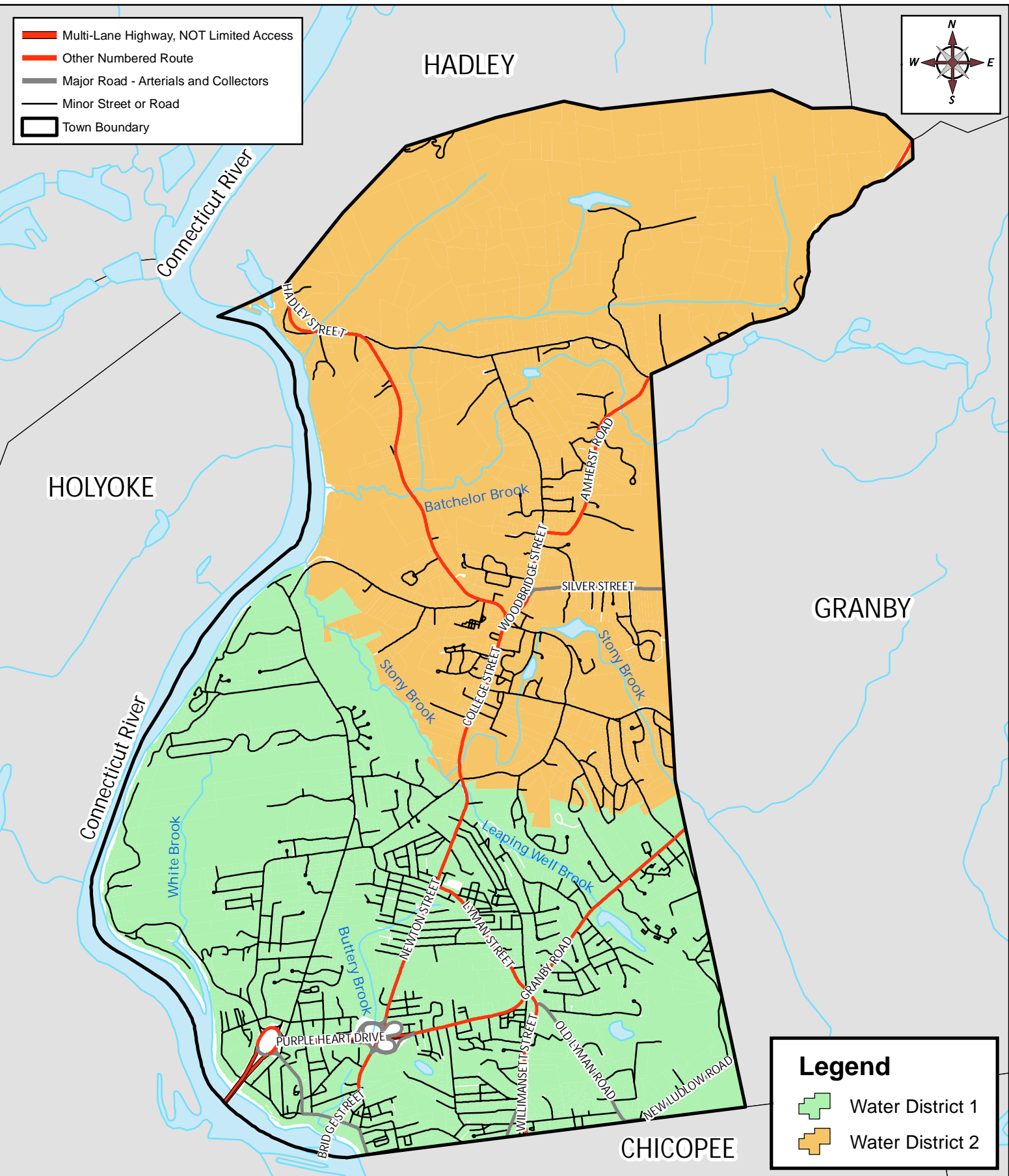
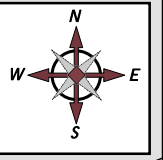
-  Multi-Lane Highway, NOT Limited Access
-  Other Numbered Route
-  Major Road - Arterials and Collectors
-  Minor Street or Road
-  Town Boundary



Legend





-  Water District 1
-  Water District 2

Comprehensive Wastewater Management Plan (2025)



Town of South Hadley, MA

Figure 4
Fire Districts

Scale: 1 inch = 4,000 feet
Source: Town of South Hadley GIS

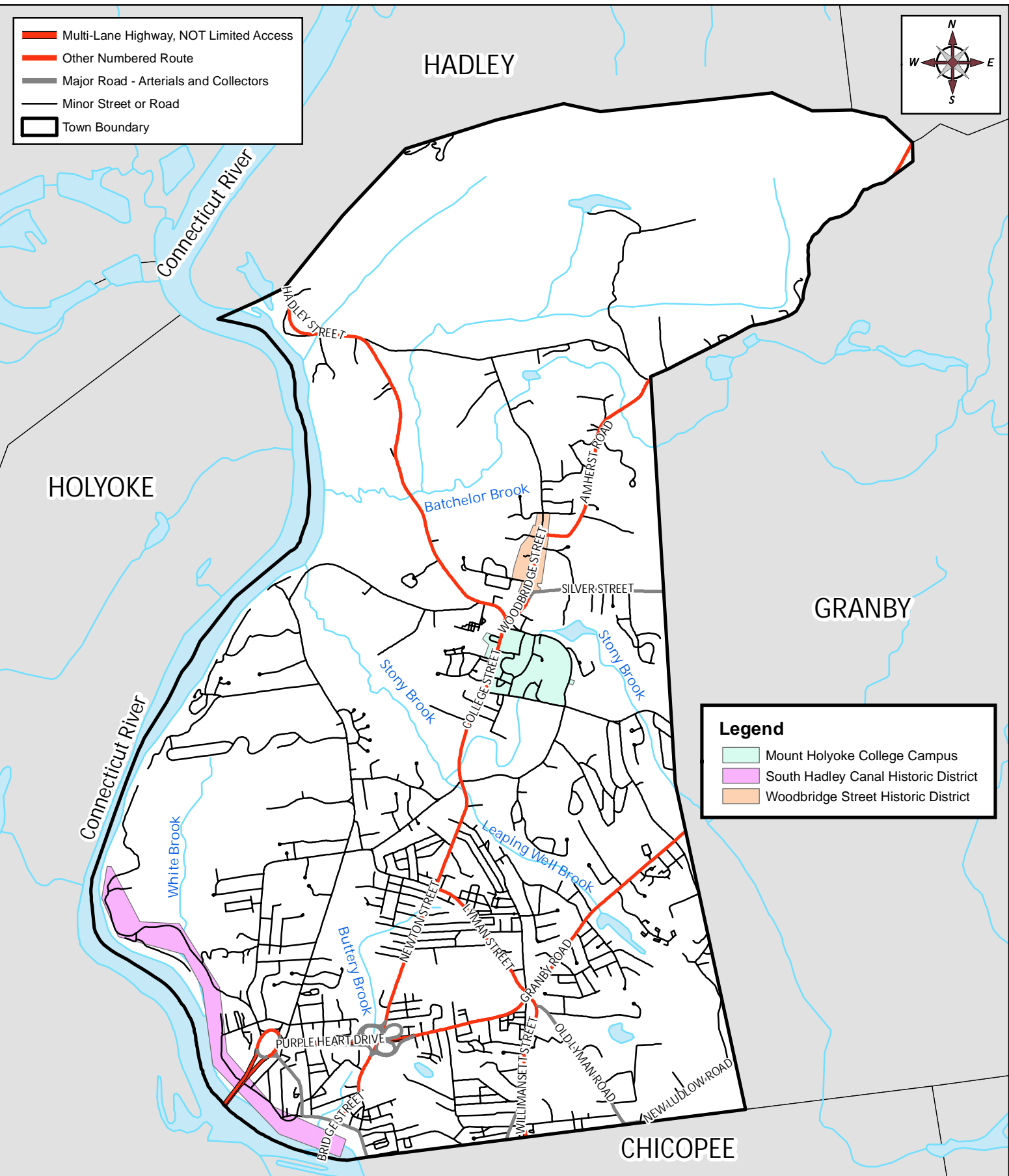
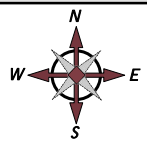
-  Multi-Lane Highway, NOT Limited Access
-  Other Numbered Route
-  Major Road - Arterials and Collectors
-  Minor Street or Road
-  Town Boundary



- Legend**
-  Mount Holyoke College Campus
 -  South Hadley Canal Historic District
 -  Woodbridge Street Historic District

Comprehensive Wastewater Management Plan (2025)

Town of South Hadley, MA

Figure 5
Historic Districts

Scale: 1 inch = 4,000 feet
Source: Town of South Hadley GIS

2.1.7 GEOLOGY, TOPOGRAPHY, AND SOILS

Geology & Topography

The Connecticut River Valley has been physically developed by the continental drift, the formation of the Appalachian Mountain Chain, volcanic activity, and glacial erosion. These forces have influenced South Hadley's topography, soil composition, surface and groundwater features, forestation, and ultimately, land utilization.

Soils





The U.S. Department of Agricultural Natural Resources Conservation Service (NRCS) provides soil data and information through their web-based soil survey database for the nation's counties. Soil data for South Hadley is included in the Soil Survey of Hampshire County, Massachusetts, Central Part and includes information on the type of existing soils, groundwater conditions, and provides insight into the suitability of soils for specific uses, including septic tank absorption fields.

The Soil Survey provides very detailed information on the different soil classifications and their locations within the County. When evaluating the soil classifications for an entire town such as South Hadley, it can be difficult to determine the general soil layout. Because of this, the Soil Survey has generated a general soil map that categorizes the soil classifications based on geographical patterns, parent material, and limitations for particular uses and names these general groups of soils, or associations, based on the dominant soil type. The predominant soil associations present in South Hadley are depicted in Figure 6 and are discussed briefly below.

- Hinckley – Merrimac – Windsor Association:
 - Major limitations of this soil association include rapid permeability and steep slopes.
 - All three major soils are rated as "severe" for septic tank absorption field use due to poor filtration.
- Amostown – Scitico – Boxford Association:
 - Major limitations of this soil association include wetness and slow permeability.
 - All three major soils are rated as "severe" for septic tank absorption field use due to wetness and slow percolation.
- Narragansett – Holyoke Association (Rock outcrop):
 - Major limitations of this soil association include shallow depth to bedrock.
 - Both major soils are rated as "severe" for septic tank absorption field use due to slope and depth to bedrock
- Gloucester – Montauk – Paxton Association:
 - Major limitations of this soil association include stones at the surface, slope, and slow permeability.
 - All three major soils are rated as "severe" for septic tank absorption field use due to slope and slow percolation rates.







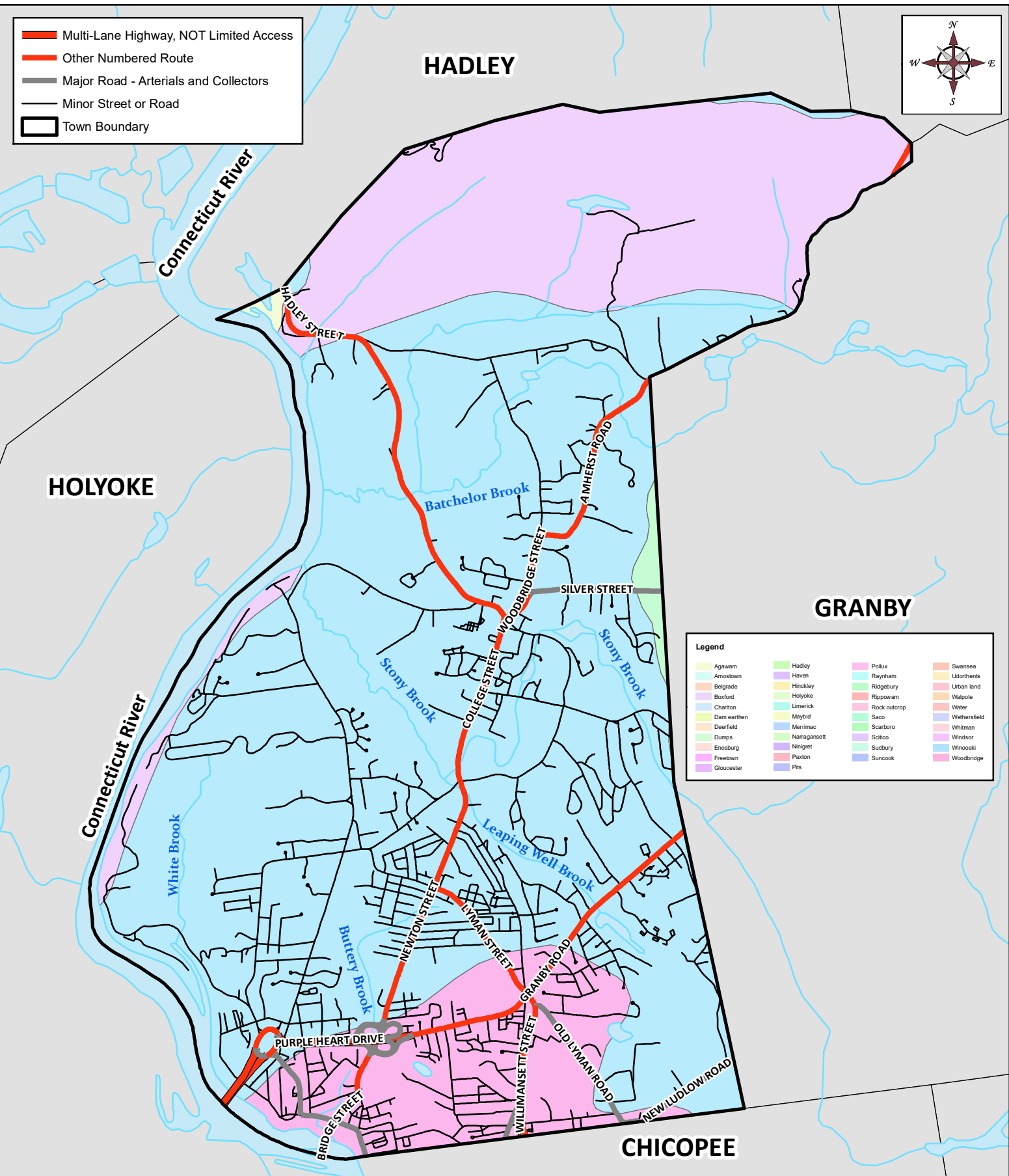



































2.1.8 FLOODPLAINS AND WETLANDS

The Federal Emergency Management Agency's (FEMA) Flood Insurance Rate Maps (FIRMs) depicts the 100-year floodplain (an area that has a 1% chance of flooding during any given year) at the banks of the Connecticut River as well as portions of Bachelor Brook, Stony Brook, and Buttery Brook. Revisions to the

-  Multi-Lane Highway, NOT Limited Access
-  Other Numbered Route
-  Major Road - Arterials and Collectors
-  Minor Street or Road
-  Town Boundary



Legend

 Agawam	 Hadley	 Pollux	 Swansea
 Amostown	 Haven	 Raynham	 Uxbridge
 Belgrade	 Hinkley	 Ridgely	 Urban land
 Boxford	 Holyoke	 Rippowam	 Walpole
 Charlton	 Limerick	 Rock outcrop	 Water
 Dam earthen	 Mayfield	 Saco	 Wethersfield
 Deerfield	 Merrimac	 Scarborough	 Whitman
 Dumps	 Narragansett	 Solico	 Windsor
 Enosburg	 Ninigret	 Sudbury	 Winoski
 Freetown	 Paxton	 Suncook	 Woodbridge
 Gloucester	 Pitts		



TOWN OF
SOUTH HADLEY
MASSACHUSETTS

Comprehensive Wastewater Management Plan (2025)

Town of South Hadley, MA

**Figure 6
Soil Mapping**

Scale: 1 inch = 4,000 feet
Date: August 1, 2025

FIRMs have been proposed but have not yet been approved by FEMA. Revisions are only available in Paper copy.

Wetlands within South Hadley are mainly located along the banks of the Connecticut river and the four brooks/streams in town. These wetlands provide flood control to these major water resources as well as fish and wildlife habitats. In 2005, the Town implemented their first Wetlands Bylaw which established a 50-foot no disturb zone, referred to as the "Conservation Zone," that adjoins all wetlands and larger vernal pools. The Conservation Commission adopted regulations to this Bylaw in 2011.

The 100-year floodplain and wetlands of South Hadley have been depicted in Figure 7.

2.2 ON-SITE WASTEWATER DISPOSAL SYSTEMS (TITLE 5)





Based on Town records, approximately 450 properties have their wastewater disposal needs served by on-lot sewage disposal systems. Most of these properties are located in the northern half of the Town and along the banks of the Connecticut River. After speaking with South Hadley's Board of Health regarding areas in Town that experience issues with their on-lot disposal systems, the following list was generated:

1. Hadley Street (north of Bachelor Brook)
2. Pearl Street
3. Amherst Road
4. Meadow Lane, Woodbridge Road, Woodbridge Terrace, and Red Ledge Road
5. East Street (near the Granby Town line)
6. Cove Island and River Road



All of the problem areas identified above were also identified in the Town's 2001 Comprehensive Wastewater Management Plan. Common problems with septic systems in the noted locations are ledge, high groundwater table and soils with drainage limitations. It should be noted that there are only about 130 homes in these areas. In many cases, the Town's sewer system is present in the area but was not extended to the identified streets due to topographic limitations. Areas currently served by on-lot disposal systems are shown in Figure 8. The figure also shows where there are limitations related to the function of soil absorption systems.

Cove Island lies within the floodplain of the Connecticut River. Many homes are seasonal cottages that are only used during summer months or seasonal cottages that have been converted to year-round use. Many of these properties have been retrofitted with innovative on-lot disposal systems to meet wastewater disposal needs. In the past, sewer extensions to Cove Island have been discouraged because it could promote development in an area subject to flooding. Due to the limited number of existing homes in the area, the cost of a municipal sewer extension to Cove Island has been demonstrated to be very expensive on a per lot basis.

In the Pearl Street area in the northern section of Town, soil is predominantly characterized as sandy and can readily pass percolation tests stipulated in Title V regulations. Issues with on-lot disposal system are primarily due to their age. Pearl Street is sparsely developed so a sewer extension is unlikely. However, it is included as a needs area if a sewer extension is desired by property owners in the area. Pearl Street would represent the northern limit of the wastewater collection system.

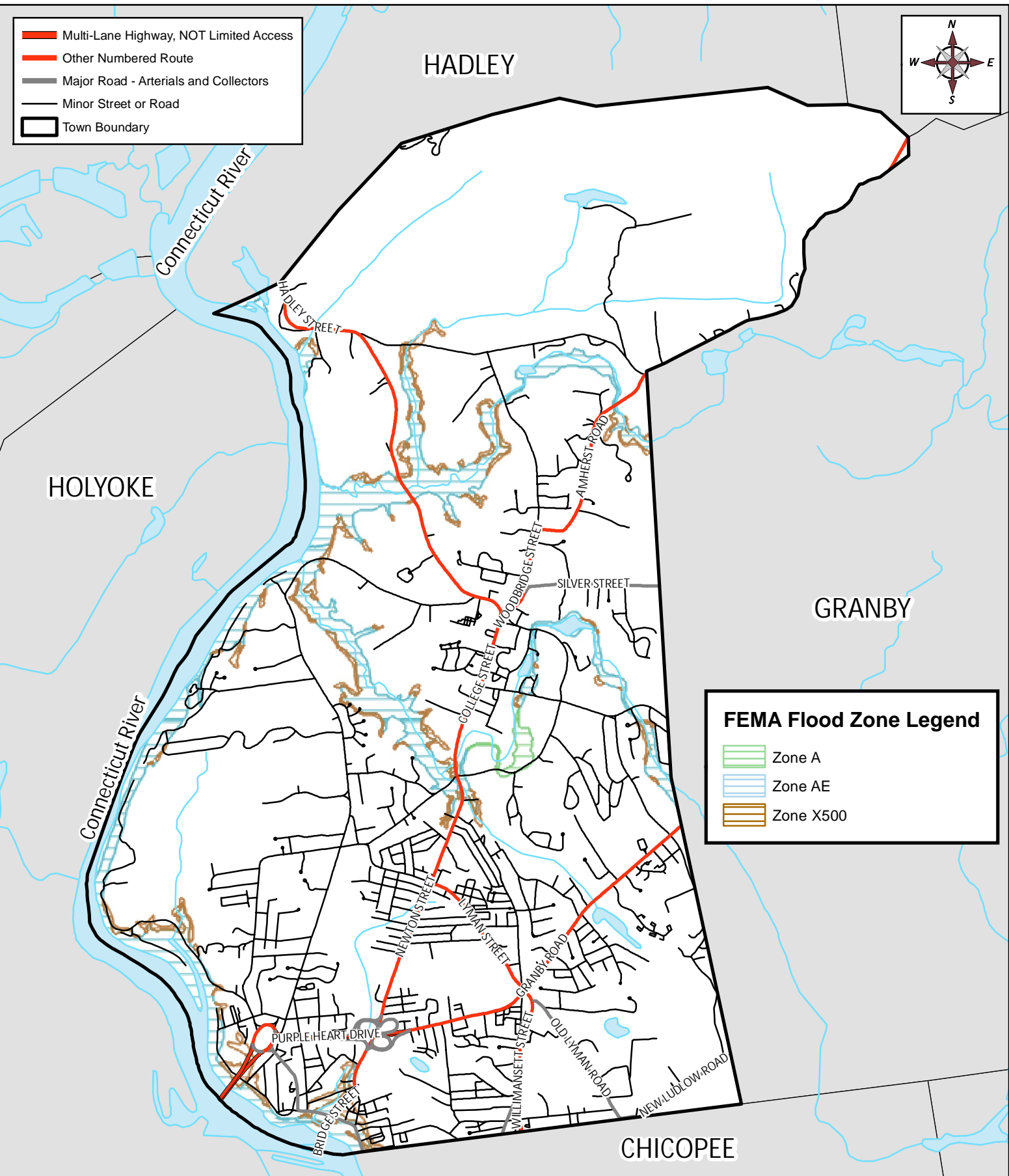
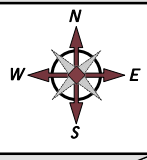
-  Multi-Lane Highway, NOT Limited Access
-  Other Numbered Route
-  Major Road - Arterials and Collectors
-  Minor Street or Road
-  Town Boundary



- FEMA Flood Zone Legend**
-  Zone A
 -  Zone AE
 -  Zone X500



TOWN OF
SOUTH HADLEY
MASSACHUSETTS

Comprehensive Wastewater
Management Plan (2025)

Town of South Hadley, MA

Figure 7
FEMA Flood Plains

Scale: 1 inch = 4,000 feet
Source: Town of South Hadley GIS

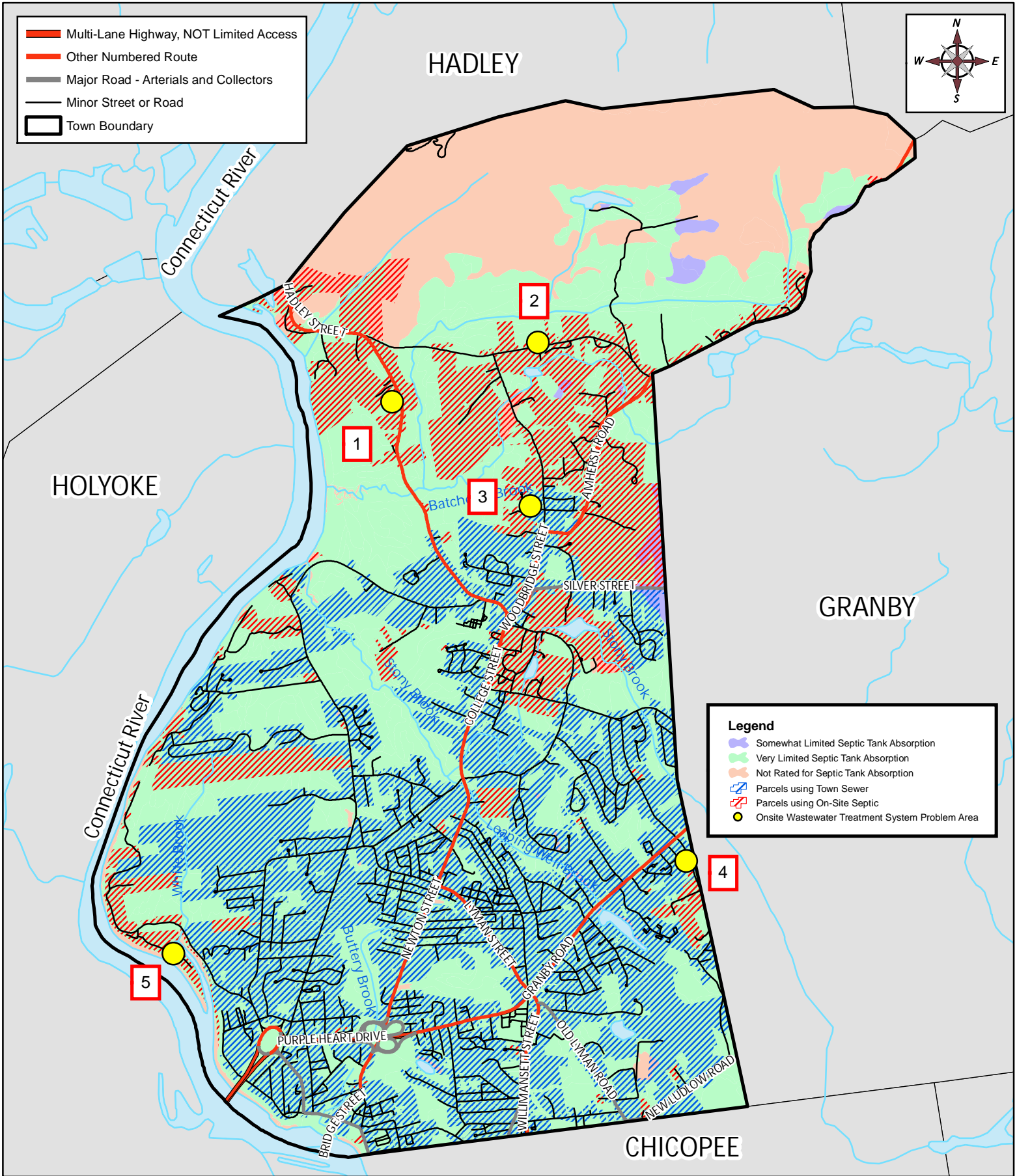

3.0 WASTEWATER COLLECTION SYSTEM EVALUATION

3.1 HISTORICAL CONTEXT

The South Hadley sewer system is made up of approximately 85 miles of pipe (both pressure and gravity), five (5) sewage pumping stations, 8 siphons and a WWTP located at 2 James Street in the abutting City of Chicopee. South Hadley possesses a NPDES Permit for its WWTP allowing it to discharge treated effluent from Outfall 001 to the Connecticut River. Sewer sizes range from 6-inches to 30-inch diameters and are age typical in construction with older sections constructed of either vitrified clay, asbestos cement, reinforced concrete, or prestressed concrete pipe; with newer sections constructed primarily with PVC. A map depicting the existing sewer collection system and the associated features is provided as Figure 9.

The sewer system serves approximately 95% of the town of South Hadley with a total service population of about 17,300. South Hadley also has inter-municipal agreements with the Town of Granby and the City of Chicopee for the treatment of sanitary wastewater from small portions of these communities. There are 359 residential and commercial connections in Granby contributing an average daily flow contribution of 75,000 gallons. Similarly, there are 289 residential and commercial sewer connections in Chicopee that contribute 45,000 gallons of wastewater per day to South Hadley. All wastewater in the system flows to the Main Street Pump Station then to the WWTP.

When South Hadley was originally incorporated in 1775, it was divided into two villages; the Falls area located along the Connecticut River, and the Center Area located approximately two miles north of the Falls Area. Sewers in these two areas, which were predominantly combined for stormwater and wastewater collection, were originally constructed from 1920 to 1950. At one time, the South Hadley sewer system had a total of 16 CSOs in its system.

The Falls and Center areas were connected in 1960 when the initial construction of South Hadley's primary Wastewater Treatment Plant (WWTP) was also completed. The primary treatment facility removed settleable solids and provided disinfection capabilities prior to the wastewater being discharged to the Connecticut River. Although a majority of the sewer system has been separated and the CSOs effectively eliminated, portions particularly in the Falls area, likely have sources of inflow connected to the wastewater system.

3.2 INTERCEPTOR SEWERS

South Granby Road Interceptor Sewer

The South Granby Road interceptor sewer extends from the last industrial building on New Ludlow Road, down Abbey and Tampa Streets, then down the south side of Granby Road before connecting to the Judd Brook interceptor on Newton Street. A majority of the pipe was installed in the 1950's and is mostly 8- and 10-inch asbestos cement pipe. Much of the interceptor was installed at minimum slope resulting in limited hydraulic capacity and areas with limited velocity. To alleviate solids settling out in the line, a diversion vault was installed in 2008 halfway down Abbey Street, diverting flow to another sewer in Susan Avenue. The service area is extensive, serving mix of residential and commercial/industrial users.

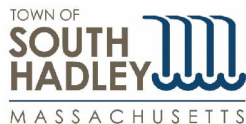
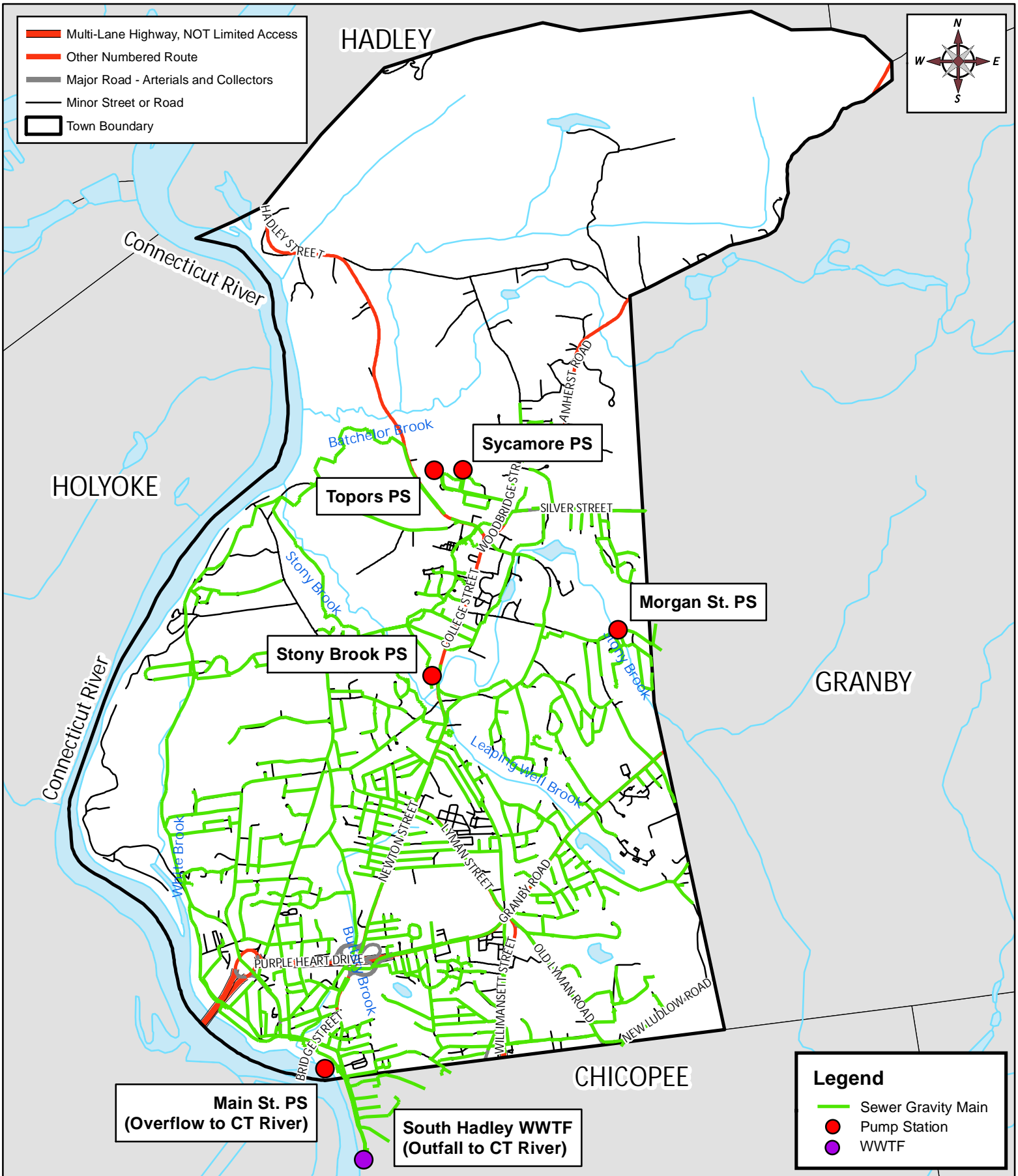

Comprehensive Wastewater Management Plan (2025)

Town of South Hadley, MA

Figure 9
South Hadley Sewer System

Scale: 1 inch = 4,000 feet
Source: Town of South Hadley GIS

Mount Holyoke College (MHC) Interceptor Sewer

The MHC interceptor sewer system extends from Silver Street, through the MHC campus, and eventually connects to a siphon on College Street, near Leahy Avenue. The interceptor was installed in the 1920's with various pipes consisting of clay, asbestos cement, and concrete. Pipe sizes range from 12 inches at Silver Street to 20 inches on Stanton Avenue. Although the system has a limited-service area, based on pipe sizes and the former CSO by the lower pond dam was originally designed to carry both sewage and stormwater. The CSO has been eliminated and the collection system is now separated.

Center Interceptor Sewer

The Center Interceptor was installed in the 1930s and serves the west side of College Street in South Hadley Center down to the Stonybrook Pump Station. In the 1950's, this interceptor discharged untreated sewage into Stony Brook. This was eliminated when the original Stonybrook Pump Station was constructed in the late 1950's. The discharge pipe was left active as CSO #10 to relieve excess flow in the pipe. The CSO was eliminated following a station upgrade in 2008.

Judd Brook Interceptor Sewer

The Judd Brook sewer System extends from the intersection of Alvord Street and Pine Street to Main Street in the Falls area of Town, generally following Judd Brook and eventually Buttery Brook. The majority of the pipe was installed in the 1950's and consists of asbestos cement pipe varying in size from 10 inches on Alvord Street to 18 inches in the School & Main Street area of Town. This system provides sewer service to significant portions of South Hadley. In the Falls area, the sewer has a hydraulic capacity of 3.55 MGD based on record plan information, which should be more than adequate. However, this system, due to its proximity to the brooks, has capacity concerns which are evident during high groundwater periods and heavy rain events. The Town recently completed a major construction project on the interceptor to alleviate some of this additional flow, as discussed more fully in Section 3.4.

3.3 BYPASSES AND COMBINED SEWER OVERFLOWS (CSOs)

Following the completion of the Lower Connecticut River CSO Study in 1988, the Town began aggressively working to eliminate all of the CSOs as stipulated in a MassDEP Administrative Consent Order as well as a USEPA Consent Decree. The process of eliminating the South Hadley CSOs included partial sewer separations, diversion of surcharged sewers into higher capacity pipelines, removal of direct inflow sources and the upgrade on the Main Street Pump Station to increase its capacity.

Before the Town initiated the sewer separation projects mentioned above and some of the efforts to remove infiltration and inflow, there were sixteen (16) combined sewer overflows (CSOs) within the collection system. These overflows served to prevent the wastewater treatment plant from becoming inundated during wet weather events. The Town has spent a considerable amount of time and effort to eliminate all CSOs throughout the years. After many upgrades were completed to the collection system, including pump stations and the wastewater treatment plant, all of the CSOs have been eliminated. The last two, #004 Main Street and #012 Gaylord Street, were effectively eliminated in the summer of 2008 as part of the two-stage CSO Flow Diversion Project mentioned above.

However, to serve as a fail-safe method of protection for the Main Street pump station and local homes in the event of increased flow, equipment repair or malfunction, an Emergency By-Pass valve has been installed at the Main Street Pump Station. The bypass consists of a 24-inch pipe installed from a manhole just upstream of the pump station to the bank of the Connecticut River. The bypass piping contains a manually operated, buried gate valve. Prior to opening the valve, operators must get approval from the

WPC Superintendent, Chief Operator, or the DPW Director. Exercising the gate valve during periods of normal pump station operation will not result in an overflow event because the overflow pipe invert is approximately 6 feet above the top of the pump station inlet pipe.

During the slide gate and valve replacement project that was performed in 2019, the Main Street station needed to be bypassed entirely. At that time, bypassing was performed by drawing wastewater from the upstream manholes via two diesel driven bypass pumps, discharging into the 10-inch drain line located within the wet well, with eventual conveyance to either the existing 24-inch and/or 16-inch diameter forcemains. Though the bypass pumping strategy was successful, a massive failure within the discharge line to the connection at the 10-inch diameter pipe resulted in an estimated 284,000 gallons of wastewater being discharged into the Connecticut River. Therefore, new permanent bypass connections were installed onto the 24-inch diameter and 16-inch diameter forcemains. The bypasses consist of new connections to the forcemains, a buried gate valves, and an aboveground standpipe to allow the connection of diesel driven bypass pumps. Wastewater would be drawn from the upstream influent manholes, as previously utilized when the station was bypassed in 2019.

3.4 INFILTRATION AND INFLOW (I/I) REDUCTION

The Town has continually worked to identify and address Infiltration and Inflow (I/I) within the sewer system. The removal of I/I was not only integral to eliminating the CSO's, but also in reducing surcharges within the sewer system and reducing extraneous flow to the wastewater treatment plant. Originally, reporting requirements for I/I were included as part of the NPDES Permit for the WWTP, however, in 2017 it became a State program under MassDEP. Requirements include submission of a 5-year plan (projects), with annual reporting on progress, and average and peak I/I flows.

Specific projects that have been completed include:

- 1998-2002 Mount Holyoke College (MHC) Building separations - Residential properties (Clapp and Carr buildings) with direct storm water connections owned by MHC were removed from the sanitary sewer.
- 2004 and 2005 Center Interceptor Sewer Upgrade - Rehabilitation of the cross-country section of the Center Interceptor north of the Hadley and Woodbridge Street Intersection. Work included 1,000 feet of sewer line replacement and rehabilitation.
- 2005 Judd Brook Interceptor I/I Study - Work consisted of I/I and SSES evaluations of the interceptor and its tributary sewersheds.
- 2005 Town Common Project - Installed a new storm sewer while disconnecting two identified catch basins from the sanitary sewer.
- 2006 Mount Holyoke College Interceptor Flow Monitoring - perform flow monitoring on the MHC 18-inch interceptor.
- 2006 Morgan Street Sewer Improvement Project - Replaced 450-feet of vitrified clay pipe and manholes with new PVC piping and 2 precast concrete manholes.
- 2005-2008 Wastewater Treatment Plant, Main Street and Stony Brook Pump Station Upgrades, Upgraded Main Street and Stony Brook Pump Stations and eliminated the two CSO outfalls at their respective locations. WWTP improvements included the replacement of pumps, primary clarifier drives, grit facility, blowers, gravity thickener mechanisms, comminutors, and instrumentation.
- 2006-2007 Silver Street and Silverwood Terrace Separation Project - Removed four identified catch basins from the sanitary sewer and connected them to an existing storm drain.

- 2007-2008 Silver Street and Greenwood Lane Sewer Improvement - Replacement of 700-feet of cross-country sewer line with new pipe.
- 2007-2008 CSO Flow Diversion Project – Two-stage project that addressed surcharging conditions in the Judd brook interceptor and eliminated two CSO structures. Included the installation of 2,000 feet of new 15-inch sewer to intercept and divert flow to the Connecticut River Interceptor and the installation of 2,900-feet of 12-inch PVC sewer on Abbey and Laurie Streets.
- 2008 Stony Brook Pump Station Bypass - eliminated the CSO formerly located at the pumping station and installed an overflow line from the pump station to the Brainerd Street Sewer.
- 2009 Brainerd and Lyman Streets Sewer Separation - Extended the existing storm sewer 300-feet and disconnected 2 high volume catch basins from the sanitary sewer.
- 2009 Judd Brook and Main Street Interceptor Flow Monitoring - Enhanced the previous 2005 study by obtaining data from gaylord to school streets and the Main Street Interceptor along the South Hadley Canal.
- 2010 Storm Water Incentive PVPC Grant: Removed 17 sump pump and roof leader connections from the sanitary sewer.
- 2010 Berwyn Street Project - Disconnected two catch basins from the sewer system.
- 2010 High Street Project - Disconnected two catch basins from the sewer system and connected them to the existing storm drain system.
- 2013-2014 Newton Street Sewer Replacement - Replaced 200-feet of damaged vitrified clay pipe with PVC pipe. Rerouted the Newton Street sewer to eliminate old sewer line and manholes.
- 2014 Leahy Street Sewer Replacement - Repaired 85-feet of 10-inch sewer and disconnected two catch basins connected to the sanitary sewer.
- 2016 Camden and Dayton Streets Sewer Replacement - Replaced 500-feet of broken pipe that was below the groundwater table with new pipe and structures.
- 2016 Main Street – 300 feet of concrete pipe replaced with 10-inch SDR 35, and 2 catch basins removed from a cross connection.
- 2021 Dayton Street/Route 116 - Separation of two catch basins from the sewer system.
- 2021 Pittroff / Richview Street - Separation of one catch basin from the sewer system
- 2022 Abbey St. @ Plainville – install overflow into 8-inch line
- 2023 – Raised a manhole structure on Mary Lyon
- 2025 – 3 sanitary sewer manholes hydraulically sealed (OBIC system lining) by Precision Trenchless LLC.
- 2022-2025 – Judd Brook Lining project prep work, design and construction. The scope of the project included:
 - Heavy Cleaning of 4,400 feet of 12-inch, 14-inch, and 18-inch pipe
 - Heavy Cleaning of 650 feet of 20-inch pipe
 - Lining 800 feet of 12-inch pipe
 - Lining 5,700 feet of 14-inch to 20-inch pipe
 - Several point repairs on the interceptor.
 - Lining over 400 vertical feet in manholes

In 2016, the new I/I requirements for MassDEP went into effect. The 2 major components were the completion of an I/I study and submittal of a five-year plan for I/I reduction by December 2017. Due to

the ongoing drought conditions at the time, Wright-Pierce prepared an Infiltration and Inflow Report for South Hadley based on previous reports and historical data for the plant and pump stations. The report addressed baseline estimates of infiltration and inflow, assessed the effectiveness of I/I reduction efforts performed to date and specifically the collection system response during the 5-year, 24-hour storm. Data from 2008 to 2017 was reviewed to find a storm event with a rainfall depth similar to a 5-year, 24-hour design storm. A storm event on July 23, 2008, produced 4.22 inches of rain, which was the only event that met or exceeded a 5-year, 24-hour storm. A storm event on August 9, 2013, fell just short of a 5-year, 24-hour storm event, producing only 3.52 inches. Neither of these storm events resulted in an SSO in South Hadley's system. The study also reviewed flow records for the Topors, Morgan Street and Stony Brook Pump Station. The results demonstrated that each pump station is impacted by inflow, but the impacts vary depending on wet weather conditions. The Town committed to completing actual flow monitoring in each of the sewer basins as part of the five-year plan.

2020 Flow Monitoring Study – South Granby Interceptor

The flow metering program included the installation, maintenance, and analysis of five meters over the course of the 6.5-week monitoring period from November 11, 2020, through December 28, 2020. During the months of November and December, sewer data was documented at 15-minute intervals and monitored for general trends and anomalies.

Night flow isolations (NFI) were performed to supplement the flow monitoring program and to find excessive infiltration areas that can be targeted for closed-circuit television (CCTV) pipe inspections. Instantaneous flow measurements were taken at selected manholes using a flow measuring device. The measurements took place between 10:00 PM and 4:00 AM, when wastewater production is expected to be the lowest. Night flows for each isolation area were normalized based on inch-diameter-mile to compare rates more accurately across each area. A total of 0.106 mgd of baseline sewer flow and 0.162 mgd of baseline infiltration was identified in the meter basins. None of these rates were considered excessive.

2022 Flow Monitoring Study (West Basins 5 and 7)

In 2022, flow meters were installed at various locations in the areas tributary to the Morgan Street and the Stony Brook Pump Stations. Two meter-basins and four night-flow isolation measurements had baseline infiltration greater than the threshold of 4,000 gpd/idm. Additionally, four areas were identified with excessive inflow rates. Additional work was recommended in these areas.

2023 Flow Monitoring Study (Center/MHC Interceptors)

In 2023, a Flow Monitoring Study for the Mount Holyoke and Center Interceptors was completed. The Study concluded that both basins are being impacted by localized excessive infiltration. The report recommended that for the areas indicated to have excessive or inconclusive infiltration, the Town may consider performing additional infiltration field investigative work to identify infiltration sources.

The flow metering data also showed that both meter basins are subject to inflow during wet weather events. Comparing the net inflow volume during the five rain events captured, the Mount Holyoke basin exhibited a greater inflow contribution than the Center basin.

2024 Flow Monitoring Program – West Basins 1,3,4 and 6

Extraneous flow was evaluated to determine which sub-basins require additional sanitary sewer evaluation survey (SSES) field work to identify potential sources of I/I in the wastewater collection system.

The flow metering program included the installation and maintenance of 8 meters over the course of a 10-week monitoring period from April 26, 2024, through July 2, 2024. During this period, wastewater flow data was documented at 15-minute intervals and reviewed for general trends and anomalies. A total of 1.23 mgd of base sanitary flow, 1.22 mgd of base infiltration and 2.91 mgd of inflow (1-year, 6-hour design storm) were identified in the meter basins. Per MassDEP Guidelines, further investigation and rehabilitation may be cost-effective in basins where base infiltration flows equal or exceed 4,000 GPD/IDM. Excessive infiltration was identified in the West-1 meter basin. Excessive inflow was identified in the West-1 and West-3 meter basins. The I/I Flow monitoring reports with flow meter locations, results and final recommendations are available at the Wastewater Treatment Plant. The locations of sewersheds are shown in Figure 10.

2022 and 2025 Judd Brook Flow Monitoring

The Town has recently completed a major construction project to rehabilitate and remove infiltration and inflow from the Judd Brook Interceptor. The intent of the project was to remove up to 0.4 mgd of base infiltration that had been identified in the interceptor by lining over 6000 feet of pipe.

To assess the impact of the Judd Brook Interceptor rehabilitation project, flow monitoring data collected from September 30, 2024 through December 18, 2024 was compared to flow monitoring data completed in the Judd-1 and Judd-3 sewersheds prior to the lining project from August 30, 2022, to November 14, 2022. The amount of flow passing through Judd-1 and Judd-3 sewersheds decreased significantly after the rehabilitation of the interceptor and manholes. Average flow in the Judd-1 sewershed decreased by approximately 5 percent, while average flow in the Judd-3 basin decreased by nearly 65 percent. Flow data is presented below.

<u>2022 Flow Data (Pre-Rehabilitation)</u>			
<u>Sewershed</u>	<u>Location</u>	<u>Average Flow (mgd)</u>	<u>Peak Flow (MG)</u>
Judd-1	MH-1600	0.62	2.17
Judd-3	MH-1095	0.32	0.97

<u>2024 Flow Data (Post-Rehabilitation)</u>			
<u>Sewershed</u>	<u>Location</u>	<u>Average Flow (mgd)</u>	<u>Peak Flow (MG)</u>
Judd-1	MH-1600	0.59	1.85
Judd-3	MH-1095	0.11	0.31

In summary, although the Town no longer has CSOs and does not have storm related SSO's, there are still areas that are known to have I/I. There are several sections of Town with high groundwater tables, and associated residential inflow, which cannot be easily addressed. Many of the Town's sewer interceptors are located alongside brooks, streams and swamps, and can be expected to have sources of infiltration. Per MassDEP, going forward these will still need to be addressed, even if the Town's systems are adequate to handle the flow. It should be noted that South Hadley has entered into an agreement with Wright-Pierce to complete a GIS layer in the sewer database that will track infiltration and inflow related work, beginning with the studies discussed above. The layer will include sample points, relevant data, and highlight areas of concern. This will provide consistency in sample data collection and assist the Town in its decision-making process as improvements are planned and implemented.

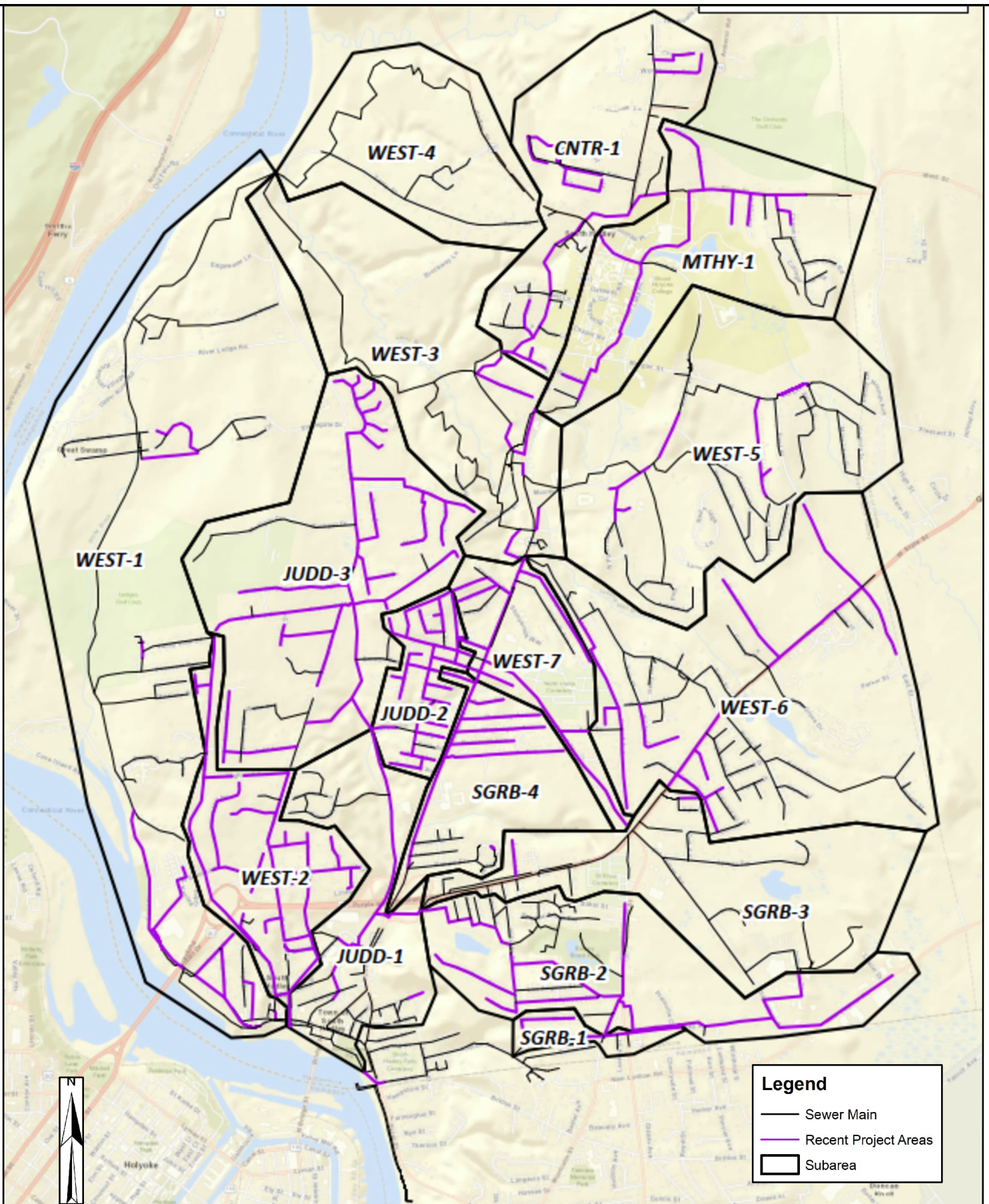

3.5 PUMPING STATIONS

Five (5) pumping stations, including the Main Street Station, are located within the South Hadley collection system. The locations of each pump station are depicted in Figure 9. As part of this CWMP, each pump station was visited and evaluated to determine the existing conditions and recommended improvements needed over the next 20 years. A general summary of the pumping stations is included in Table 3-1 below:

Table 3-1 – Wastewater Pumping Stations

<u>Station Name</u>	<u>Number of Pumps</u>	<u>Capacity Per Pump (GPM)</u>	<u>Rated Pump Station Capacity (mgd)</u>	<u>Year Constructed (Last Upgrade)</u>	<u>Station Type</u>	<u>Standby Generator Onsite</u>
Main Street	4	2,900	10.7	1978 (2008)	Wet Well/Dry Well	Yes
Stony Brook	2	320	0.5	1976 (2008)	Submersible	Yes
Morgan Street	2	150	0.2	1991	Suction Lift	Yes
Topors	2	52	0.15	1970's	Pneumatic Ejector	Yes
Old Sycamore	1 compressor	75	0.1	1960's	Pneumatic Ejector	No

2022-2024 Pump Station Data Review

Using the flow data provided by the Town, the average daily flow, peak infiltration, peak inflow, and estimated delayed inflow for the Treatment Plant, Morgan Street, Stony Brook, and Topor Pump Stations were calculated. Average daily flow and peak infiltration rates are summarized below:

<u>Location</u>	<u>Average Daily Flow (GPD)</u>	<u>Peak Infiltration (GPD)</u>	<u>Peak Inflow (GPD)</u>
<u>2022</u>			
Morgan Street PS	36,600	28,330	68,550
Stoney Brook PS	17,300	12,070	171,520
Topors PS	2,760	2,140	4,100
<u>2023</u>			
Morgan Street PS	58,540	32,880	317,000
Stoney Brook PS	28,460	12,860	428,000
Topors PS	3,900	3,600	5,300
<u>2024</u>			
Morgan Street PS	41,200	38,700	175,000
Stoney Brook PS	23,000	20,200	220,000
Topors PS	3,200	3,600	4,200

Main Street Pump Station

The Main Street Pump Station, which conveys all of the wastewater collected in South Hadley, Chicopee and Granby to the wastewater treatment plant, was constructed in 1975. It is located near Beachgrounds Park on Main Street in South Hadley, approximately one-half mile from the treatment facility. The influent sewer enters the station through a single 30-inch diameter pipe. The discharge forcemain is a dual design. The previous station on this site had a 16-inch diameter asbestos cement forcemain that remained in place when the new pump station was constructed. A new 24-inch diameter ductile iron forcemain was constructed as part of the new station. Pump flow leaves the building through a single 24" ductile iron forcemain and then flow can be sent to either the 16" AC, the 24" DI, or both forcemains. The forcemains are tied together with a cross-connection consisting of 10-inch diameter ductile iron pipe and valves that allows either force main to drain back to the wet well when not in use.

The pump station consists of a four-level concrete/brick building where Level 4 is located at grade and Levels 1 through 3 are located below grade. The facility is constructed with a separate wet and dry well where four vertical dry pit pumps are located within the dry well on Level One (the bottom level of the station). Three of the pumps are original equipment. The fourth pump was installed in 2007 to provide redundancy. Each of the 125-hp pumps is rated for 2,900 GPM (4.2 mgd) at 84-feet of TDH. Motors are controlled by variable frequency drives (VFDs) located within the Motor Room on Level 4. With three pumps in operation, the peak flow that can be conveyed to the treatment facility is 10.74 mgd. A diesel-powered standby generator that provides backup power to the Main Street Pump Station is also located within the Motor Room on Level 4. Level 2 of the wet well houses two channel-type grinders (Dimminutors™) and ancillary equipment. One of the 5-HP grinders was replaced in 2024 and the second is scheduled for replacement in FY 2026.

Level 3 contains the boiler used to heat the dry well. It also contains the water meter for the potable water supply and the back flow preventer for the non-potable plant water system. This non-potable system provides seal water to the sewage pumps and water for other maintenance purposes.

In February 2023, Wright-Pierce conducted a thorough evaluation of the Main Street Pump Station. Major recommendations from that evaluation are summarized as follows:

Process

- Replace the three older pumps with an option to replace the newer pump. The newer pump has now been in service for 18 years and it should be replaced when the upgrade is undertaken. All pumps should be replaced with dry-pit submersible pumps to eliminate the extended shafts and offer protection if the station were to flood.
- Replace all valves, pipe, and pipe supports.

Architectural

- Replace exterior doors.
- Address general condition of wet side of station (i.e., cleaning, painting, replacement of corroded metal throughout.
- Address code issues through ventilation on dry side (NEC Class 1, Division 2).
- Provide flood protection for station by providing a water barrier at the exterior doors. It was determined that 0.6 feet of additional height is required above existing finished floor.

Structural

- Address life safety issues on wet side including toe plates, safety rails to replace chains, new grating and handrails.
- Add lift hook capacities and replace/repair hooks, as needed.
- Address corroded metal on wet side by replacing handrails, hatches, and grating.
- Repair concrete on the wet side as significant concrete resurfacing is required.
- Repair cracks through pressure injection on the dry side.
- Add signage indicating capacity of generator lifting hooks and the capacity of the monorail.

Mechanical (HVAC/Plumbing)

- Replace all ventilation in the station. The dry side of the station requires continuous ventilation to declassify the space from Class 1, Division 2.
- Replace heating system in entire station.
- Replace station plumbing, including fixtures, valves, piping.
- Replace floor drains and sump pumps.

Instrumentation

- Replace main control panel.
- Add fiber optic connection for future communication at the pump station.
- Add lightning suppression to antenna cable.
- Replace level controls and floats.
- Replace venturi tube with magnetic-type flow meter.
- Install person-down, room switches and flood switches for life safety.

Electrical

- Replace the generator. Funding is in place and it will be procured by the Town ahead of the upgrade project.
- Upgrade the service transformer. The transformer has been purchased and is being held until the upgrade project commences.
- Replace all electrical distribution equipment (MCCs) and pump VFDs. It should be noted that the pump controller recently failed and replacement parts are no longer available. The Town was forced to purchase a refurbished part with an undefined life expectancy.
- Replace all station lighting with light-emitting diode (LED) lighting.
- Install pump e-stops on all levels on dry side, unless dry pit submersible pumps are selected.

Wright Pierce's opinion of probable project costs for the upgrade, in 2023 dollars, was \$9,492,000.



Main Street Pump Station 4th Floor: Four (4) Vertical Dry Pit Pump Motors.



Main Street Pump Station 4th Floor: Generator.

Stony Brook Pump Station

The Stony Brook Pump Station was last upgraded in 2007-2008 when the station was converted from a pneumatic ejector to a submersible pump station. Two submersible pumps, each rated for 320 GPM at 45-feet of TDH, are located in a wet well outside of the station's enclosure. It was recently demonstrated that with both pumps operating, the station output is 524 gpm. Each is equipped with a mixed flush valve. A stainless-steel rock trap is located upstream of the pumps within the wet well. The pumps discharges through a 12-inch force main. Alternatively, the station can discharge to the two 8" siphons located just northwest of the pump station. A natural gas fired generator is located on the main level of the Station. Alarms are connected to the Mission Control system.

Concerns identified at the station include:

- a natural gas odor upon entering. The Town has investigated the issue and have not found a cause.
- the roof is damaged and is in need of replacement.
- the top of the cupola on the roof is damaged/missing, which allows rainwater to enter the station.
- water enters the vent above the generator.
- if the station becomes inundated, wastewater overflows through a manhole located north of the station. The overflow pipe is located approximately 14 feet above the bottom of the wet well.
- the generator and automatic transfer switch were installed in 2008 and are within their useful lives of 20 years but will require replacement in approximately 5 years.
- HVAC equipment was installed in 2008 and has approximately 15 years of life expectancy remaining.
- except for the slop sink and hot water heater, plumbing equipment has approximately 30 years of life expectancy remaining. The slop sink appears to be original to the building construction and is in poor condition. The hot water heater has passed its useful life expectancy of 10 years.
- from a review of FEMA flood map 2501700010 A and Lidar topographical data available through the National Oceanic and Atmospheric Administration (NOAA), critical infrastructure is located more than 3-feet above the 100-year elevation.

Morgan Street Pump Station

The Morgan Street Pump Station is a small, duplex suction lift station located on Morgan Street east of Mount Holyoke College at the Stony Brook crossing. The pump station was constructed in 1991 to replace an older ejector type station that was constructed in the mid-1960s. The station consists of a wet well, two suction lift pumps rated at 150 gpm at 45 feet TDH, fiberglass enclosure above the wet well that houses the pumps, and another small enclosure that houses a natural gas standby generator and electrical controls for the station. The station services homes in the general vicinity of the facility, which includes a few homes located in the Town of Granby. It discharges through a 6-inch force main to the gravity sewer located on Morgan Street at the intersection of Sharon Street. The station is connected to the WPCF Mission Control alarm system.

Primary concerns with the Morgan Street Pump Station are:

- difficulty with priming the pumps. It should be converted to a submersible style station.
- limited site access for pump trucks and other large equipment.
- generators are considered past their useful life and replacement parts are no longer readily available. If a generator were to fail, replacement or repairs on site would be difficult, costly and



Stony Brook Pump Station: Pump House.



Stony Brook Pump Station: Wet Well & Submersible Pumps.

result in the standby power system power capacity be cut in half for an extended period of time. Due to water conservation measures, once through water cooling with municipal water are no longer an acceptable method for generator cooling.

- HVAC equipment within the building has approximately 5 years of life expectancy remaining. The pump station exhaust fan has exceeded its useful life of 20 years.
- plumbing equipment has 10 to 15 years or so of life expectancy remaining.
- from a review of FEMA flood map 2501700010 A and Lidar topographical data available through the National Oceanic and Atmospheric Administration (NOAA), critical infrastructure is located more than 3-feet above the 100-year elevation.

Topors Pump Station

The Topors Pump Station is a small pneumatic ejector station that services approximately 10 to 15 homes north of Mount Holyoke College. This station was constructed in the late 1970's and is located in the middle of a cul-de-sac on Sycamore Park. The station is equipped with two ejector pots that are each rated at 52 gpm. The station consists of an underground wet well vault with above grade access, air compressor, timers, and a natural gas standby generator. The Topors Pump Station receives overflow from the Old Sycamore Pump Station in the event Old Sycamore is inundated or offline. Alarms from this station are connected to the Mission Control system.

The following concerns were noted in the station:

- three-way valves constantly need to be repaired.
- the home at #13 Sycamore Park has a gate valve in the basement which is used to prevent backups in basement when an issue occurs at the station. Town personnel Town needs to knock on resident's door to notify them, but this is an issue if no one is home. There is a high-level float specifically placed to notify the Town before this service is affected.
- the residence at #14 Sycamore Park has a buried check valve to prevent basement backups when an issue occurs at the station. There is a high-level float specifically placed to notify the Town before this service is affected.
- ladder used to enter wet well is slippery.
- access to wet well is very small and operators must raise their arms to enter.
- the generator and the automatic transfer switch are considered past their useful lives of 20 years, and replacement parts are no longer readily available. At this point the generator is not considered a reliable source of power in the event of utility power outage.
- the ejector station exhaust fan has exceeded its useful life of 20 years.
- gas piping has approximately 10 years of life expectancy remaining.
- from a review of FEMA flood map 2501700010 A and Lidar topographical data available through the National Oceanic and Atmospheric Administration (NOAA), critical infrastructure is located more than 3-feet above the 100-year elevation.



Morgan Street Pump Station: Pump House



Morgan Street Pump Station: Wet Well Enclosure for Submersible Pumps.



Topors Pump Station: Prefabricated Pneumatic Pump Station.

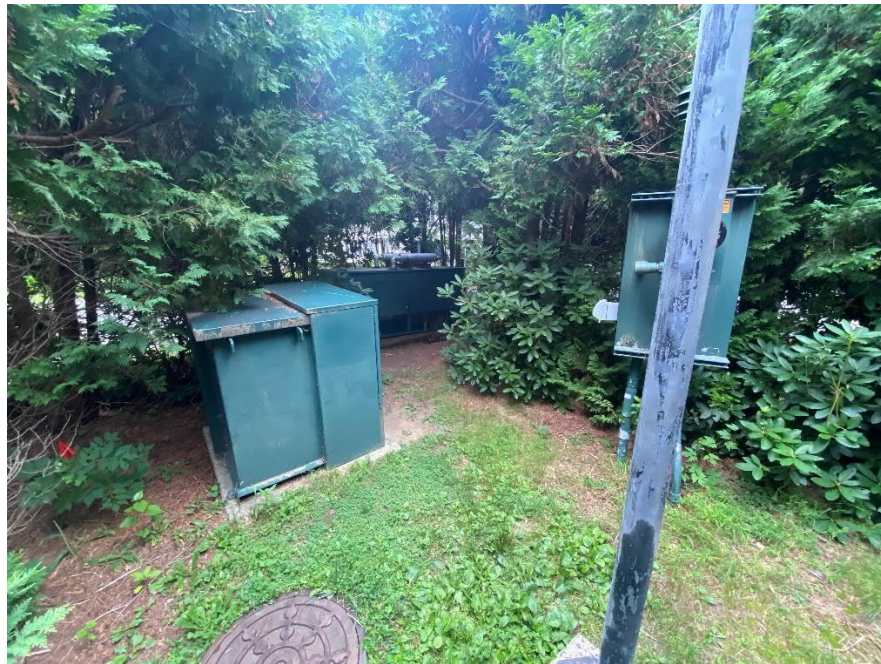

Topors Pump Station: Generator and transformer.

Old Sycamore Pump Station

The Old Sycamore Pump Station is the oldest pump station in Town as it was constructed in the 1960's. This facility services approximately 30 to 40 homes in a subdivision north of Mount Holyoke College. It discharges through a 6-inch force main to gravity sewer on Woodbridge Street. The ejector station, which presently conveys approximately 10,000 gpd of wastewater, has a capacity of 75 gpm. The station includes ejector pumps, one air compressor, and three-way valves. Old Sycamore does not have a standby generator since flow can be directed to an overflow pipe, located within the wet well that discharges to the Topors Pump Station. Old Sycamore is the only pump station that is not connected to the Town's Mission Control alarm system. However, a local alarm (red indication light) signals when there is an issue at the station.

Besides the overall age of the station and the equipment within, other issues include the lack of a ladder assist on the access ladder and the suction line is leaking where the pipe penetrates the station wall.

Electrical equipment as a whole appears to be older than 30 years and past its useful life. The non-explosion proof equipment installed in the station is a violation of the electrical code requirements and creates potential for an explosion. It is recommended that this station be abandoned and that all flow be directed to the Topors Station on a permanent basis.



Old Sycamore Pump Station: Meter and prefabricated Pneumatic Pump Station Enclosure.



Old Sycamore Pump Station: Transformer.

4.0 WASTEWATER TREATMENT PLANT EVALUATION

The South Hadley Wastewater Treatment Plant (WWTP) is located on James Street in Chicopee, MA. However, the facility primarily treats wastewater for approximately 95% of South Hadley’s residents and small sections of the Town of Granby and the City of Chicopee. The plant was originally constructed in 1960 as a primary treatment facility with anaerobic digestion of biosolids. With wastewater conveyed to the treatment plant, raw sewage discharges at various points in the collection system were eliminated. An upgrade to the facility was constructed in the late 1970s to achieve secondary treatment standards using a conventional activated sludge process. Vacuum filters incorporated into the upgraded treatment plant to dewater biosolids were replaced with a belt filter press in 1991. This improved the efficiency of the sludge dewatering process. At that time, the gaseous chlorination system used to disinfect the wastewater prior to discharge, was replaced with a sodium hypochlorite injection system. The last upgrade to the WWTP was completed in 2008, which included the replacement of four (4) mechanical aerators, other plant mechanical equipment, and the inclusion of an activated carbon odor control system. A site plan for the current WWTP is provided as Figure 11.

4.1 DISCHARGE PERMIT

The South Hadley WWTP is authorized to discharge treated effluent to the Connecticut River under NPDES Permit No. MAG590021. The Town of South Hadley is the permittee, and the Town of Granby is identified as a co-permittee relating to operation and maintenance of the sewer system. The permit number assigned to the Town of Granby for purposes of reporting is MAG59C121. Previously, the City of Chicopee was also listed as a co-permittee. A copy of the permit is provided in Appendix A. Discharge limitations imposed by the Permit, which became effective on April 1, 2023, are summarized below in Table 4-1.

Table 4-1
 Existing NPDES Permit Discharge Limitations (2023 Permit)

Effluent Characteristics	Discharge Limitations		
	Average Monthly	Average Weekly	Maximum Day
Flow ¹	4.2 MGD	--	--
BOD ₅	30 mg/L (1,051 lb/day)	45 mg/L (1,576 lb/day)	--
BOD ₅ Removal	≥85%	--	--
TSS	30 mg/L (1,051 lb/day)	45 mg/L (1,576 lb/day)	--
TSS Removal	≥85%	--	--
Escherichia coli ^{2, 4}	126 colonies / 100 mL		409 colonies / 100
Total Residual Chlorine	1.0 mg/L	--	1.0 mg/L
Total Nitrogen ³	350 lb/day	--	--

1. The flow limit is a rolling 12-month average that is calculated as the arithmetic mean of the monthly average flow for the reporting month and the monthly average flows of the previous eleven months.

2. Monthly average limits for bacterial are expressed as a geometric mean.

3. The total nitrogen limit is a rolling 12-month average that is calculated as the arithmetic mean of the monthly average total nitrogen for the reporting month and the monthly average total nitrogen for the previous 11 months.

4. Limit applies from April 1 to October 31.

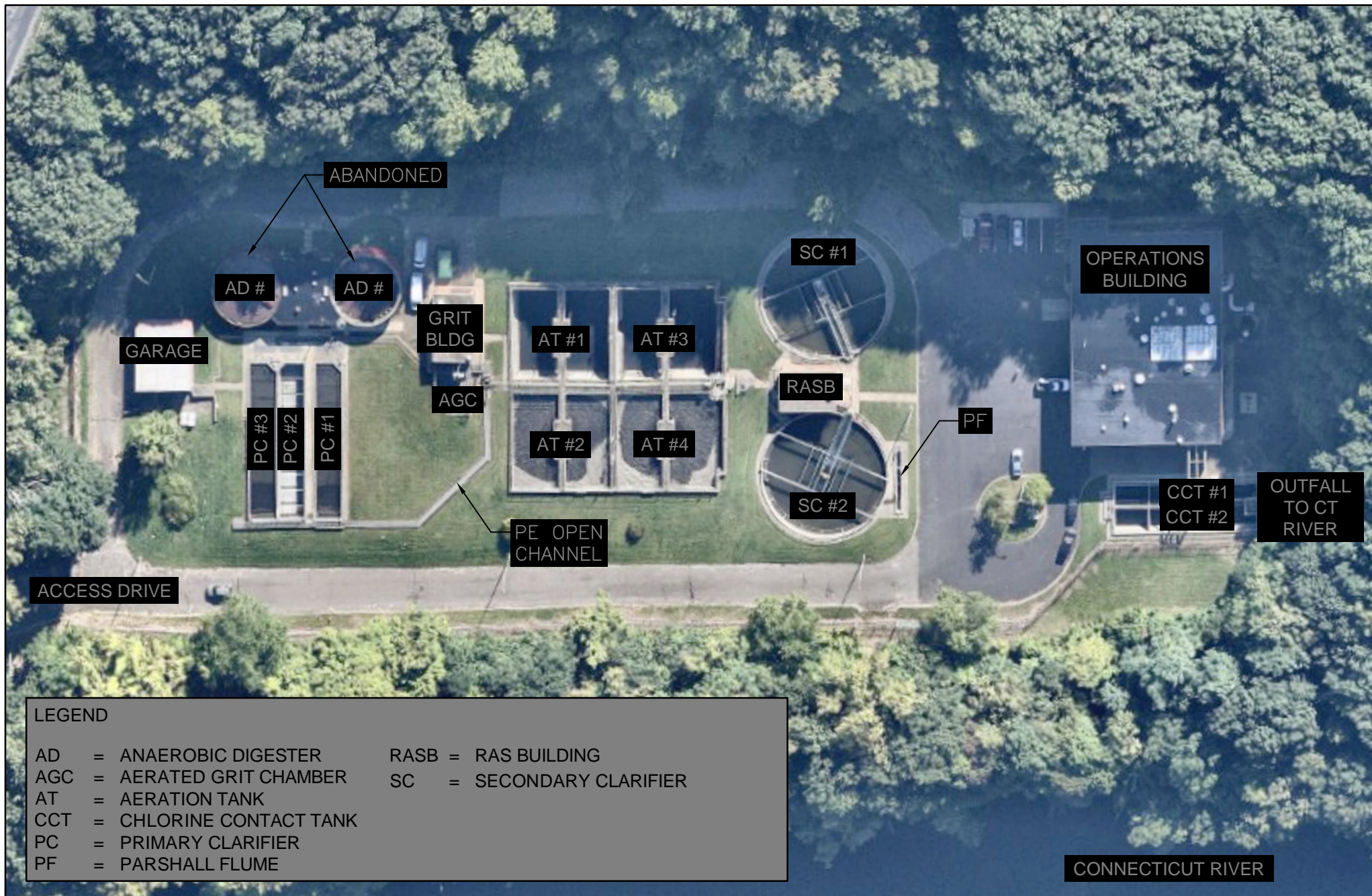

Numerical limitations in the new permit for Biochemical Oxygen Demand (BOD), Total Suspended Solids (TSS), and Chlorine Residual are the same as they were in the previous permit issued in 2012. The mass limit imposed on Total Nitrogen is new and will require an evaluation of alternatives to achieve compliance.

4.2 TREATMENT PLANT FLOWS & LOADS

4.2.1 EXISTING WASTEWATER FLOWS

The WWTP is currently designed for an average daily flow of 4.2 million gallons per day (mgd) and a peak hourly design flow of 10.74 mgd (flow capacity of the Main Street Pump Station). The design flow is limited by the size of the primary clarifiers as other treatment processes are designed for an average daily flow of 5.1 mgd. It should be noted that the design flows and the treatment processes stated above were established for a conventional activated sludge process providing secondary treatment. They do not account for the new NPDES permit requirement to remove total nitrogen which will increase the process oxygen demand and possibly necessitate a change in use of process tanks. These factors could impact the treatment capacity of the plant.

Historical flow data spanning from January 1, 2021 to December 31, 2024 has been evaluated to determine current flow rates at the South Hadley WWTP. A summary of this data is presented in Table 4-2. As shown, the average annual wastewater flows for 2021, 2022, 2023 and 2024 were 3.30 mgd, 2.82 mgd, 3.05 mgd, and 2.56 mgd, respectively. As discussed earlier in this section, the permitted flow for the WWTP is a rolling 12-month average of 4.2 mgd. Over this time period, the 12-month rolling average flows ranged from 2.56 mgd to 3.42 mgd with the higher value reported in April 2022. The average of the 12-month rolling average flows over the study period was 3.05 mgd.

The data also demonstrates that flows to the WWTP are impacted by rainfall (refer to Figure 12). Maximum daily flows to the WWTP routinely exceed 8 mgd following precipitation events. Monthly flows where substantial rainfall has occurred have also exceeded the average day design capacity of the WWTP, as noted below. Although the WWTP can handle and treat wastewater during these times, it is worth noting.

<u>Month</u>	<u>Average Day WWTP Flow (mgd)</u>	<u>Monthly Precipitation</u>
July 2021	5.09	11.63
January 2023	4.58	7.11
March 2023	4.95	5.09

As previously discussed in Section 2.1.5, water billing data was reviewed for fiscal year 2023, which was provided by the water departments of Fire District #1 and #2. From an analysis of this data, it was determined that the average daily water consumption rate is 1.24 million gallons per day (MGD). This accounts for residential, commercial, industrial and institutional consumption. Assuming that 90-percent of the metered potable water consumed entered the Town's wastewater collection system, these sources are estimated to contribute, on average, approximately 1.11 MGD of wastewater to the system, or 60.5 gallons per capita per day on a population basis.

Table 4-2
 WWTP Effluent Flows (2021 – 2024)

2021				
Month	Average Monthly Flow (MGD)	Maximum Daily Flow (MGD)	Total Monthly Rainfall (in.)	Maximum Daily Rainfall (in.)
January	3.37	5.03	2.37	1.55
February	2.74	3.65	3.42	1.30
March	2.94	4.21	2.18	0.94
April	2.65	4.35	5.09	2.16
May	3.39	5.28	5.93	1.60
June	2.65	3.67	3.17	1.08
July	5.09	12.08	11.63	3.60
August	3.26	5.82	5.11	2.10
September	3.80	9.46	6.10	4.10
October	3.32	5.76	4.73	1.38
November	3.23	4.50	2.73	1.40
December	3.14	3.92	4.22	1.23
Annual Average:	3.30	Sum:	56.68	
2022				
Month	Average Monthly Flow (MGD)	Maximum Daily Flow (MGD)	Total Monthly Rainfall (in.)	Maximum Daily Rainfall (in.)
January	2.80	3.86	4.36	2.20
February	3.07	6.19	3.42	1.80
March	3.36	4.59	4.12	0.80
April	4.00	6.33	4.76	1.72
May	2.82	3.81	3.80	0.90
June	2.15	2.70	2.66	1.00
July	2.08	2.52	4.53	1.34
August	2.04	2.60	3.22	1.10
September	2.63	6.42	6.56	2.10
October	2.54	3.62	3.96	1.82
November	2.75	3.88	2.96	1.00
December	3.58	5.46	4.17	0.78
Annual Average:	2.82	Sum:	48.52	
2023				
Month	Average Monthly Flow (MGD)	Maximum Daily Flow (MGD)	Total Monthly Rainfall (in.)	Maximum Daily Rainfall (in.)
January	4.58	9.27	7.11	1.30
February	3.12	3.99	1.42	0.50
March	4.95	7.37	5.09	2.28
April	2.71	4.81	3.89	1.60
May	2.54	4.17	4.00	1.98
June	1.82	2.03	3.27	0.85
July	2.98	6.93	9.10	1.50
August	2.01	2.84	3.90	1.18
September	2.67	8.96	10.46	3.75
October	3.09	5.92	2.91	0.89
November	2.47	3.12	2.18	0.70
December	3.71	8.00	6.78	2.00
Annual Average:	3.05	Sum:	60.11	

Table 4-2
 WWTP Effluent Flows (2021 – 2024) (Cont'd)

2024				
Month	Average Monthly Flow (MGD)	Maximum Daily Flow (MGD)	Total Monthly Rainfall (in.)	Maximum Daily Rainfall (in.)
January	4.66	8.52	6.65	2.89
February	3.29	4.86	1.66	0.58
March	4.73	8.97	8.61	2.08
April	3.99	6.63	4.44	1.25
May	2.54	3.26	4.61	1.25
June	2.14	3.51	5.21	1.98
July	1.86	2.53	3.59	0.89
August	1.86	2.54	3.48	0.66
September	1.38	1.60	0.73	0.33
October	1.28	1.42	0.29	0.21
November	1.32	1.72	2.89	1.02
December	1.69	2.61	5.47	1.47
Annual Average:	2.56	Sum:	47.63	

Note: Average monthly flows that exceed the design flow of the treatment facility are shaded.

Figure 12: Total Daily WWTP Flow Versus Total Daily Precipitation
 January 2021 through December 2023

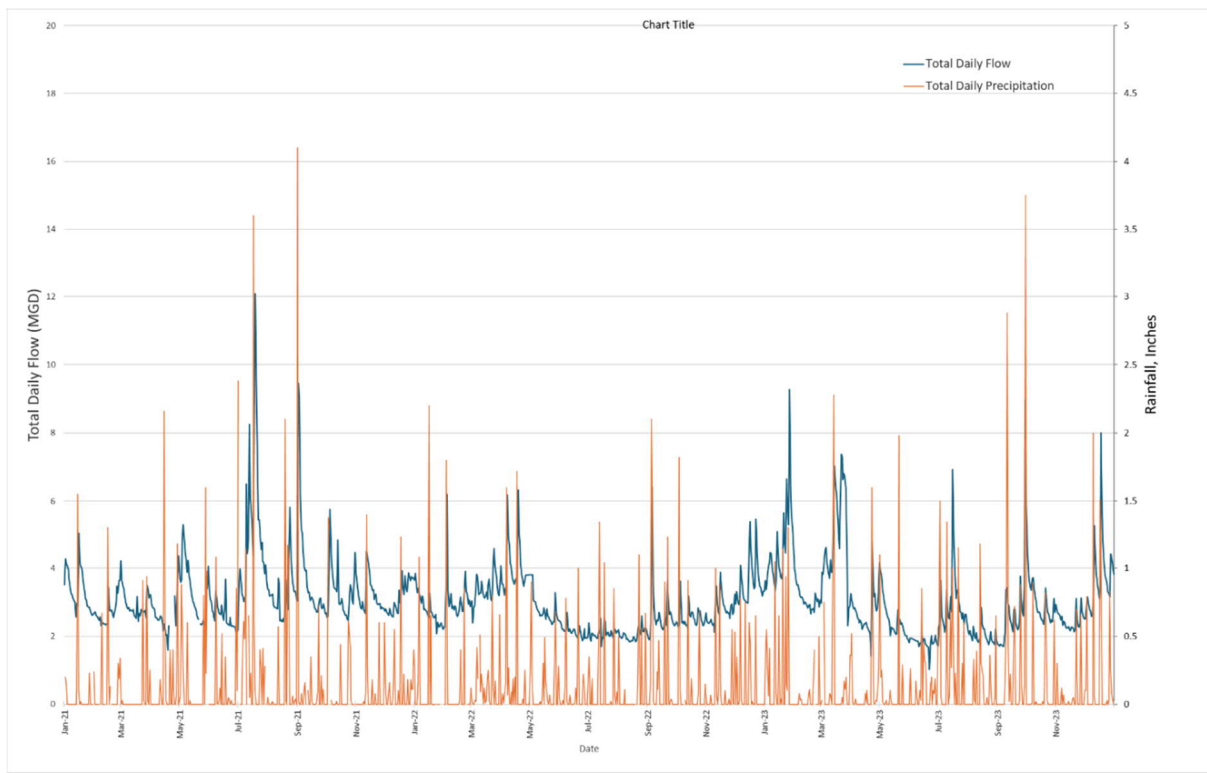

4.2.2 INTERMUNICIPAL AGREEMENTS

The Town of South Hadley has intermunicipal agreements with the neighboring communities of Granby and Chicopee for the treatment of sanitary wastewater from small, adjoining areas to South Hadley.

The agreement with the City of Chicopee is the older of the two, entered in on November 8, 1979 for a 30-year period. The agreement was automatically extended after 30 years and is in effect as long as the system remains operational. It allows the City of Chicopee to discharge 150,000 gallons of wastewater on an average day basis and 400,000 gallons on a peak hour basis. BOD and TSS loads are limited to 150 lb/d and 200 lb/d, respectively. The agreement contains requirements for construction, wastewater quality, concentration, monitoring, terms of use, sewer use billing and payments. Chicopee's current flow of approximately 45,000 gpd is from 289 homes located in the North Chicopee area adjacent to the Main Street pump station and the WWTP. While a few homes on the south side of Smith Street tie in directly to a South Hadley sewer line, most of the flow passes through a metering point near the South Hadley/Chicopee town line, located in the corner of the property at the bottom of Smith Street. This metering location is maintained by Chicopee; however, flow data is available to South Hadley through Mission Control.

The agreement with the Town of Granby is dated July 10, 1990, and contains similar requirements and terms of use as the agreement with Chicopee. The agreement was automatically extended in 2020. It allows Granby to discharge 85,000 gallons of wastewater on an average day basis and 300,000 gallons on a peak hour basis. Currently there are 359 residential and commercial sewer connections (372 equivalent dwelling units) contributing an average daily flow of 75,000 GPD. The concentrations of BOD and TSS are each limited to 250 mg/l. The Granby agreement required more sewer improvements and construction than that of Chicopee. Granby constructed a pump station on Route 202 near the South Hadley/Granby town line which collects the wastewater from the 5-corners area of Granby. Additional flow ties into the South Hadley's Morgan Street pump station, while some residences adjacent to the various Town lines are directly connected to the South Hadley sewer system. Flow data from Granby is also available to South Hadley via the Mission Control System.

4.2.3 INFILTRATION AND INFLOW (I/I) ANALYSIS

To estimate I/I rates contributing to the WWTP, the component of the average daily water consumption entering the wastewater collection system was subtracted from the measured WWTP influent flow. This analysis was conducted for both high groundwater (January-April) and low groundwater seasons (June through October) as shown below in Table 4-3. The data indicates that both the dry season flow and high groundwater season flow consists of a significant amount of I/I. The analysis indicates that 1.62 mgd and 2.19 mgd of I/I enters the collection system during the low groundwater season and high groundwater season, respectively.

During dry periods in the high groundwater season, the wastewater flow to the WWTP has fallen to 2.5 mgd whereas, the dry period flows during the low groundwater season approach 1.6 mgd. Therefore, the baseline infiltration rates in the high groundwater and low groundwater seasons are 1.31 mgd and 0.41 mgd, respectively. The baseline infiltration rates suggest that a majority of the extraneous flow entering the South Hadley wastewater collection is rainfall derived infiltration and inflow. Significant increases in flow occur during rain events and remain elevated for several days following. Potential sources of direct inflow include sump pumps, roof leaders and area drains that are tied into the sewer system.

It should also be noted that during the latter part of 2024, much of New England experienced drought conditions. Average monthly flows from September through November were 1.38 mgd, 1.28 mgd and 1.32 mgd, respectively. These flow rates closely approximate the baseline wastewater flow in the South Hadley collection system with minimal contributions from infiltration.

Table 4-3
 Estimated I/I Rates (Years 2021-2023)

Flow Contribution	Average Daily Dry Season Flow (MGD) ¹	Average Daily Wet Season Flow (MGD) ²
Fire District #1	0.84	0.84
Fire District #2	0.28	0.28
WW Flow from Granby & Chicopee ³	0.07	0.07
Septage ⁴	0.00	0.00
Average Daily Flow	2.81	3.38
Estimated Infiltration/Inflow	1.62	2.19
¹ Average for the months of June through October ² Average for the months of January through April ³ Average daily flows for Granby & Chicopee ⁴ Septage quantities are negligible for this estimate		

The South Hadley Sewer Use Rules and Regulations prohibits the connection of sump pumps and downspouts into the sanitary sewer system. Beginning in 2007, the Water Pollution Control and Assessors departments joined forces to develop a program to collect information on these types of connections. A specific line on the Assessors inspection form is dedicated to collecting this information. In addition, the Assessor’s office routinely sends out questionnaires to new homeowners, and this form has also been modified to include questions on these types of connections. The information is put into the Assessor’s database, and notations can be added to reflect completed disconnections and monitor progress. The system can be queried to obtain information by street, to assist in project planning. The Building Department is also helping to educate residents and encourage disconnections from the sanitary sewer whenever possible.

4.2.4 EXISTING POLLUTANT LOADING

The South Hadley WWTP is presently designed to remove Biochemical Oxygen Demand (BOD₅) and Total Suspended Solids (TSS) from the wastewater and provide disinfection prior to discharge. The WWTP is not specifically designed or configured to remove nitrogen although some level of removal is achieved.

Influent loadings to the WWTP for Biochemical Oxygen Demand (BOD₅) and the Total Suspended Solids (TSS) are determined from 24-hour composite samples collected at a minimum frequency of once per week. This sampling protocol holds true for monitoring the WWTP effluent loadings, as required by the NPDES Permit. Influent and effluent loadings for BOD₅ and TSS for years 2021 through 2024 are summarized Tables 4-4 and 4-5, respectively. Limited influent data for total nitrogen is available, however reported total nitrogen concentrations in the effluent are provided in Table 4-6.

As shown in Table 4-4, the average daily BOD₅ load to the WWTP over this four-year period was 2,696 pounds per day. At an annual average flow of 3.05 mgd, the corresponding influent concentration was 114 mg/l. This concentration in municipal wastewater is considered very weak and indicative of dilution from infiltration and inflow. The 95th percentile of the monthly influent loading (maximum month) is approximately 4,221 pounds per day. Higher loadings were reported for the months of October and November 2023, but these are not considered representative and were not included in the calculations. Although not shown in the table, the 95th percentile of the daily influent load (maximum day) was determined as 6,170 lb/d. Effluent data demonstrates that compliance with the limits in the NPDES permit is maintained continually.

The data in Table 4-5 indicates that the average daily TSS load to the WWTP over this four-year period was 3,889 pounds per day. The months of October and November 2023 were not included in the evaluation as the data is not consistent with typical plant influent loads. At an annual average flow of 3.05 mgd, the corresponding influent concentration was 153 mg/l. Again, not inclusive of October and November 2023, the 95th percentile of the monthly influent TSS load (maximum month) is approximately 9,932 lb/d. Effluent data demonstrates that compliance with the limits in the NPDES permit is maintained continually.

As previously stated, there are no processes currently employed at the WWTP that are intended to remove nitrogen. However, effluent data presented in Table 4-6 demonstrates that the WWTP is very close to achieving compliance with the 12-month rolling average limit of 350 lb/d. The average monthly discharge over the four-year study period was approximately 359 lb/d. Based on limited data, the influent TKN to the WWTP is in the range of 25 mg/l to 30 mg/l. This report will consider operational or structural alternatives to achieve permit compliance.

Table 4-4
 Monthly Average Influent and Effluent BOD Load (lb/day)

Month	2021		2022		2023		2024	
	Influent	Effluent	Influent	Effluent	Influent	Effluent	Influent	Effluent
January			1,847	148.9	1,494	383.2	3,899	247.8
February	5,194	180.4	2,215	141.5	3,484	183.1	1,615	101.0
March	4,209	180.0	1,794	159.8	4,224	450.7	2,361	282.7
April	3,896	751.4	2,269	402.6	5,627	352.8	1,667	120.7
May	3,851	192.8	1,895	203.3	3,780	507.6	3,406	348.5
June	3,479	287.2	1,591	218.2	2,693	256.4	1,758	135.0
July	3,699	430.0	1,547	202.4	2,850	412.8	1,572	180.3
August	3,460	265.6	1,852	203.8	3,021	64.1	1,504	170.5
September	2,711	393.4	2,024	348.4	3,649	88.3	945	122.1
October	1,875	362.4	2,659	146.8	7,479	105.9	1,878	67.4
November	2,081	225.4	3,182	158.5	8,750	168.0	2,342	157.7
December	2,015	274.3	2,091	199.6	2,737	285.0	1,455	1,686.7
Minimum	1,875	180.0	1,547	141.5	1,494	64.1	945	67.4
Maximum	5,194	751.4	3,182	402.6	8,750	507.6	3,899	1,686.7
Average Month	3,315	322.1	2,081	211.1	4,149	271.5	2,033	301.7

Table 4-5
 Monthly Average Influent and Effluent TSS Load (lb/day)

Month	2021		2022		2023		2024	
	Influent	Effluent	Influent	Effluent	Influent	Effluent	Influent	Effluent
January			2,347	84.8	3,425	296.4	5,471	182.2
February	6,830	113.9	2,338	98.9	4,641	91.3	2,623	52.9
March	5,560	81.9	2,139	100.1	9,170	312.2	2,160	199.8
April	5,344	1,310.8	2,833	345.1	9,871	183.1	1,641	74.2
May	4,519	126.7	2,612	121.8	5,847	636.2	7,981	314.1
June	4,391	101.4	2,134	310.1	2,594	104.8	2,289	106.1
July	5,092	276.9	2,747	84.7	4,479	736.0	1,414	101.5
August	6,246	130.1	3,094	120.2	7,215	46.4	1,392	74.5
September	3,262	248.7	4,153	503.2	9,891	51.7	854	44.1
October	1,510	309.7	2,687	106.5	13,808	65.5	2,489	34.5
November	3,211	184.9	2,594	67.7	16,177	131.2	1,856	237.9
December	3,489	165.0	2,576	113.4	4,255	187.5	1,757	79.8
Minimum	1,510	81.9	2,134	67.7	2,594	46.4	854	34.5
Maximum	6,830	1,310.8	4,153	503.2	16,177	736.0	7,981	314.1
Average Month	4,496	277.3	2,688	171.4	7,614	236.9	2,660	125.1

Table 4-6
 Effluent Nitrogen Loads (lb/d)

Month	2021		2022		2023		2024	
	Influent	Effluent	Influent	Effluent	Influent	Effluent	Influent	Effluent
January				309.5		421.3		262.1
February				498.6		433.9		316.6
March		426.0		417.7		580.2		596.9
April				484.9		398.7		279.9
May		441.4		404.9		382.3		308.7
June		454.6		224.0		373.3		298.4
July		471.5		338.3		466.4		334.5
August		390.7		292.2		172.5		300.8
September		483.5		320.2		156.1		319.0
October		565.4		232.8		146.0		234.1
November		424.4		340.2		309.6		141.1
December		335.1		342.4		320.8		155.9
Minimum		335.1		224.0		146.0		141.1
Maximum		565.4		498.6		580.2		596.9
Average Month		443.6		350.5		346.8		295.7

4.3 LIQUID TREATMENT PROCESS

Liquid treatment process incorporated into the South Hadley WWTP include raw wastewater influent pumping; preliminary treatment including grinding (at the Main Street Pump Station) and aerated grit removal; primary treatment; secondary treatment with a conventional activated sludge process and secondary clarifiers, and disinfection through liquid sodium hypochlorite injections. The treated effluent from the WWTP is discharged to the Connecticut River. The following sections describe the liquid

treatment processes in more detail. Photographs documenting existing conditions are provided for each unit process.

4.3.1 PRELIMINARY TREATMENT SYSTEM

Influent Pumping (Main Street Pump Station)

The existing preliminary treatment system of South Hadley's WWTP includes the Main Street (influent) Pump Station and the aerated grit chamber (AGC). As described in Section 3.4, four (4) 125 HP vertical dry pit pumps convey raw wastewater to the WWTP through the 16-inch and 24-inch forcemains. Prior to the wastewater being pumped from the Main Street station to the WWTP, wastewater passes through two (2) 5 Hp high flow channel grinders (dimminutors) located upstream of the pumps. The grinders shred larger debris to prevent the pumps from clogging. In the event the channel grinders are out of service, flow is directed through a channel that contains a manually cleaned bar rack to remove larger debris before getting to the pumps. One of the channel grinders was replaced in 2024 and the other is scheduled for replacement in FY 2026.

Aerated Grit Chamber

From the Main Street Pump Station, wastewater enters the WWTP at the aerated grit chamber (AGC). The AGCs are used to remove heavy, inert solids such as sand, from the wastewater. Compressed air is pumped into the wastewater flow through coarse bubble diffusers using two (2) 7.5-Hp blowers. The air effectively lowers the specific gravity of the wastewater, which allows heavy sand and grit to settle to the bottom of the chamber but keeps the lighter organic matter in suspension. Organic solids are passed on to subsequent treatment processes. Use of the two blowers are alternated on a monthly basis.

Grit removal system equipment consists of the aerated grit chambers, blowers, air diffusers, grit screw conveyor, bucket elevator, and dewatering screw. The ACG measures 19'-8" long by 17'-6" wide with a maximum depth of 11'-3" and was constructed during the 1980 upgrade of the WWTP.

Settled material collects within a channel located at the bottom of the chambers. The channel houses a 20-foot long grit screw conveyor that conveys the collected material to a chain-type bucket elevator. A 1.5-Hp motor, mounted on top of the bucket elevator, drives the grit screw conveyor and the bucket elevator. The bucket elevator lifts the collected grit out of the chambers when it is subsequently dewatered with a dewatering screw. The dewatering screw, powered by a 1-Hp motor, conveys the dewatered grit to roll-off containers in the upper-level garage area. Grit is disposed at a landfill.

Septage can be introduced to the grit chamber via a hose connection from septage tanker trucks. A hose bib on the north side of the grit building or a yard hydrant can be used to wash down the area after discharge of septage to the chamber is completed.

Physical properties of the AGC, as well as design parameters, are provided in Table 4-7 below:

Table 4-7
 Aerated Grit Chamber Data

No. of Units	1
Length (Ft)	19.67
Width (Ft)	17.5
Max. Water Depth (Ft)	11.25
Volume per Unit (Gallon)	28,970
Detention (Minutes)	
@ Peak Hourly Flow (10.74 MGD)	3.9 Minutes
@ Avg. Daily Flow (4.2 MGD)	9.9 Minutes

The New England Interstate Water Pollution Control Commission’s Guides for the Design of Wastewater Treatment Works (TR-16), states that the minimum hydraulic detention time should range from 3 to 10-minutes, which is dependent on the peak hourly flow rate. Based on the WWTP’s peak hourly and average daily flows, the facility’s AGCs meet the TR-16 design requirements. TR-16 also suggests that the length to width ratio should range from 3:1 to 8:1 to optimize efficiency. The length to width ratio of the AGC at the WWTP is 1.1:1.

The grit chamber has been in operation for over 40 years and several pieces of equipment, including the bucket elevator, grit screw conveyor, and the dewatering screw, are original to the facility. This equipment needs to be replaced. The blowers were installed in 2009 and appear to be in good condition.

4.3.2 PRIMARY TREATMENT SYSTEM

The effluent from the Preliminary Treatment process is distributed to three (3) rectangular Primary Clarifiers of equal size for removal of the floatable and settleable solids. Primary Clarifiers #2 and #3 were constructed circa 1960 while Clarifier #1 was constructed in 1976. Typically, primary clarifiers remove 30-percent of the influent BOD₅ and 60-percent of the influent TSS. These removal rates are achieved at the South Hadley WWTP.

Continuous chain and flight sludge collectors are located in each tank and scrape settled sludge from the bottom of the tanks toward the influent end of each tank where the sludge is collected in sludge hoppers (2 hoppers per clarifier). The chains and flights in all three clarifiers were replaced in 1998. A single ¾ HP motor drives the chain and flights in Primary Clarifiers #2 and #3. A separate ¾ HP motor drives the Chain and Flights in Clarifier #1. The single drive motor for Clarifiers #2 and #3 represents a common point of failure, as a failure of the motor will cause the collectors in both clarifiers to cease operating. Future upgrades of the clarifiers should include modifications to provide independent drive motors.



Aerated Grit Facility Equipment: Grit Elevator.



Grit Building: Grit Chamber Blowers (left), Grit Shute and Dumpster (center), Control Panel (right).

Two (2) 7.5-HP plunger style pumps, housed in the lower level of the Grit Building, draw sludge from the Primary Clarifiers and convey it to the Gravity Thickeners located in the Operations Building for thickening and storage. A grinder is situated on the suction side of each pump to grind large and stringy objects within the sludge before being processed. These pumps, which were installed in 2009, are nearing the end of their useful life and need to be replaced. A change in the style of pump used should also be considered during the design of future upgrades.

As the sludge collectors return to the surface of each tank, they push scum on the surface of the water towards the effluent end of the tanks. The scum is then collected and removed through a manually operated scum trough and flows by gravity to a scum well located at the head end of the tanks between Primary Clarifiers #1 and #2. In 2008, the scum collection system was upgraded and two (2) plunger style pumps, two (2) scum grinders, and associated piping and appurtenances were installed in the basement of the Digester Building. Similar to the sludge pumping configuration, grinders are located upstream of the primary clarifier scum pumps to grind the contents from the scum well prior to being pumped to either upstream of the ACGs or to the Gravity Thickener tanks.

The primary clarifiers measure 102 feet long, 16-feet wide, with an average sidewater depth of 8-feet. Each tank holds approximately 98,000 gallons. Recommended primary clarifier overflow rates provided in TR-16, should not exceed 1,200 gallons per day per square foot (gpd/ft²) for a facility with an average design flow greater than 1.0 MGD. Additionally, the overflow rate for peak hourly flow should not exceed



Primary Treatment Equipment: Primary Clarifiers #2 & #3 Drive Mechanism.

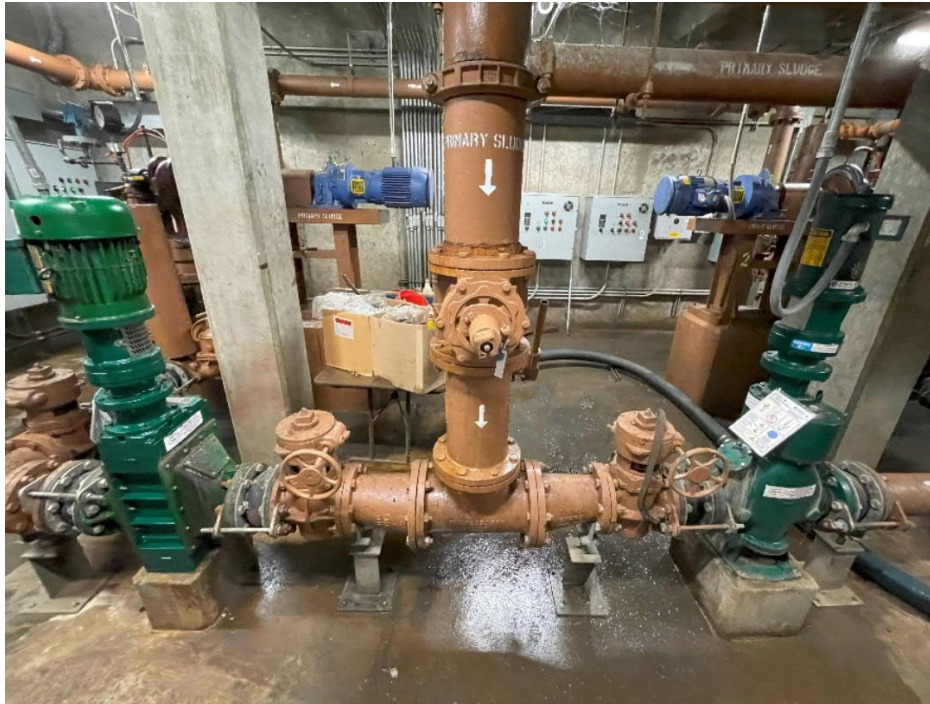

Primary Treatment Equipment: Sludge Grinders (green) & Primary Sludge Pumps (blue).

3,000 gpd/sf. Additionally, the clarifiers should be able to pass peak flows with one tank out of service. Since Clarifiers #2 and #3 have a common drive motor, failure of the motor effectively removes two clarifiers from service. Based on the data presented in Table 4-8, with one clarifier out of service, the average daily flow is limited to 3.93 mgd. Similarly, the peak hourly flow is limited to 9.79 mgd. With all three clarifiers in service, the average daily flow and peak hourly flow limits are 5.88 mgd and 14.69 mgd, respectively. Based on current flows to the WWTP, one clarifier is typically removed from service.

Table 4-8
 Primary Clarifier Surface Overflow Rates (gal/d/ft²)

	Two Primary Clarifiers in Service	Three Primary Clarifiers in Service
Total Surface Area of Clarifiers in Service	3,264 SF	4,896 SF
Average Day Flow Capacity at 1,200 gpd/ft ²	3.92 mgd	5.88 mgd
Peak Hour Flow Capacity at 3,000 gpd/ft ²	9.8 mgd	14.7 mgd

4.3.3 BIOLOGICAL TREATMENT SYSTEM

Following the Primary Treatment process, wastewater is processed through the Biological Treatment System, which consist of an Aeration System and Secondary Clarifiers. The biological system was designed to remove biodegradable organic matter and suspended solids. The new NPDES permit imposes a limit of 350 lb/d for total nitrogen, which will require nitrogen removal. Alternatives to remove nitrogen will be discussed in Chapter 6 of this document. This section will focus on existing process tanks and the capabilities of installed equipment.

Aeration System

Effluent from the Primary Clarifiers first flows through the aeration system, which consists of four aeration basins measuring 60-feet by 60-feet, with a nominal side water depth of 14-feet. The four basins are split into two trains where each train consists of two basins that operate in series. The volume of each basin is approximately 377,000-gallons. One mechanical surface aerator is located at the center of each basin, which is used to mix the content of the tanks and transfer oxygen from the atmosphere to the mixed liquor within the basin. The surface aerators in basins 1, 2 and 3, which were installed in 2009, are driven by 50-HP motors with speed controlled through variable frequency drives (VFD). The aerator in basin 4, which was installed circa 2020, is driven by a 75-Hp motor that is also controlled through a VFD. The gear boxed on The aerators are in good condition and should have 10 to 15 years of design life remaining. Their ability to meet process requirements for nitrogen removal will be evaluated.

When the secondary plant was constructed in 1976, the average daily design flow capacity of the biological treatment process was stated as 5.1 mgd. However, the overall design flow of the WWTP was reduced to 4.2 mgd (current permitted flow) due to limitations with the primary clarifiers. The peak hourly design flow of the biological process was stated as 12.74 mgd with the overall peak flow again limited by the primary clarifiers to 10.4 mgd.

The aeration system was originally designed for a maximum day BOD₅ load of 6,650 pounds per day. The original four 50 HP surface aerators were capable of delivering 8,645 pounds of dissolved oxygen per day. The increase in power of aerator no. 3 to 75 HP, increases the total oxygen transfer capacity to 9,720 lb/d. For purposes of this evaluation of the existing system capacity, it has been conservatively assumed that the oxygen transfer rate of the mechanical aerators is 1.8 lb O₂/HP-Hr.

The permit requirement to remove nitrogen will require the wastewater to be nitrified (biological oxidation of ammonia). The process requires an additional 4.6 pounds of oxygen per pound of ammonia oxidized. At an influent concentration of 25 mg/l and an average daily flow of 3.05 mgd, the average influent ammonia load is 640 lb/d with a corresponding oxygen requirement of 2,925 lb/d. Treatment alternatives are evaluated in Chapter 6.

Secondary Clarifiers

Mixed liquor from the aeration basins discharges to two 75-foot diameter Secondary Clarifiers for further separation and removal of the floatable and settleable solids. The clarifiers have a sidewater depth of 10-feet, which is shallow for their diameter. TR-16 recommends a sidewater depth of 14-feet for clarifiers of this size. The clarifiers were constructed in 1976 and with the exception of the drive motors that were replaced in 2009, most of the equipment is original. Clarifier drives, rake arms, and sludge draw-off equipment are all in need of replacement.

Clarified effluent from the Secondary Clarifiers discharges through inboard rectangular launders that include a series of v-notched weirs and continues to the Disinfection System. Settled secondary sludge is collected from the bottom of each Secondary Clarifier tank and distributed as either return activated sludge (RAS) or waste activated sludge (WAS). The RAS and WAS are collected through the clarifier's rapid sludge return system, which is a raking mechanism with a series of pipes that extends from the center of each clarifier and out to the perimeter. This system scrapes sludge from the bottom of the tank where the piping then transfers the sludge to a collection chamber located in the center of each clarifier. The WAS and RAS then flow to the return sludge well, located adjacent to the Return Sludge Pump Building. From there, the sludge is transferred by three (3) 20-Hp vertical centrifugal pumps back to either the aeration system so that an adequate biomass is maintained to accomplish treatment or to the gravity thickeners where it is processed for disposal.

WAS can also be collected within a hopper located at the center and bottom of each secondary clarifier tank. The WAS can then flow to the same return sludge well and is pumped from the Return Sludge Pump Building to the Operations Building for solids processing.

Secondary scum is collected within each Secondary Clarifier through the use of the scum skimmer, which collects the scum at the surface of each tank and pushes the scum to the effluent scum pipe. The scum then travels by gravity to the Secondary Scum Well, which is integrally cast into the concrete structure for the Return Sludge Pump Station. A single constant speed plunger pump then pumps the collected scum through a 4-inch diameter DI pipe to the Gravity Thickener for processing.



Secondary Clarifier: Secondary Clarifier #2 & Parshall Flume.



Return Sludge Pump Building: RAS Pumps.

As shown in Table 4-9, with two clarifiers in service, the surface overflow rates at average day flow and peak hourly flow are 475 gal/day/ft² and 1,215 gal/day/ft², respectively. With the current facility operating at a mixed liquor concentration of 2,000 mg/l to 5,000 mg/l and a Sludge Volume Index of 200 ml/l, the peak overflow rate is acceptable. Most processes designed to remove nitrogen are operated at mixed liquor concentrations ranging from 3,000 mg/l to 3,500 mg/l. At these mixed liquor concentrations peak overflow rates should be limited to 700 gal/day/ft² to 900 gal/day/ft².

Table 4-9
 Design Data – Secondary Clarifiers

No. of Units	2
Diameter (Ft)	75
Avg. Sidewall Depth (Ft)	10
Total Surface Area (Sq. Ft)	8,836
Total Volume (Gallons)	661,000
Overflow Rates (Gal/Day*SF)	
@ Peak Hourly Design Flow Rate (10.74 mgd)	1,215
@ Avg. Daily Design Flow Rate (4.2 mgd)	475
Retention (minutes)	
@ Peak Hourly Design Flow Rate (10.74 MGD)	89
@ Avg. Daily Design Flow Rate (4.2 MGD)	226

4.3.4 DISINFECTION SYSTEM

The existing disinfection system consists of the following components:

- Two chlorine contact chambers with a total volume of 136,000 gallons;
- Two 1,900-gallon high-density cross-linked polyethylene storage tanks with an ultrasonic liquid level sensor;
- One 410-gallon day tank constructed of high-density, cross-linked polyethylene with an ultrasonic liquid level sensor;
- One transfer pump with a capacity of 35 gpm @25 feet TDH; and
- Three metering pumps. Two of the pumps are rated at 33.3 gph @ 100 psi and one is rated for 8.2 gph @100 psi.

A 15% solution of sodium hypochlorite is stored in the two 1,900-gallon storage tanks. The transfer pump is used to convey the 15% solution to the 410-gallon day tank where it is mixed with water at a 50/50 ratio. The three metering pumps then convey the diluted solution in the day tank to the points of application. These include the diffuser at the head of the chlorine contact chamber, the RAS Building where hypochlorite is fed into the return sludge line and at the point of entry into the operations building for the waste sludge line, the primary sludge line and the treated effluent line.

As the mixed effluent passes around the baffles of the contact chambers, adequate contact time is provided between the sodium hypochlorite solution and the wastewater to provide disinfection. Based on the permit, disinfection is only required during the months of April through October when the Escherichia Coli (E. coli) limit is in effect.

From review of the design parameters for chlorination outlined in TR-16, a minimum contact period of 30 minutes should be maintained at peak hourly flows unless specific testing can demonstrate that the ability to meet the facility's discharge permit is achievable at lower contact times. As shown in Table 4-10, the contact chambers are sized to provide 46 minutes of contact at average daily design flow and 18 minutes of contact at peak hourly design flow when both chambers are in service. Operating data indicates that the wastewater can be sufficiently disinfected prior to discharge at these contact times.

Table 4-10
 Design Data – Chlorine Contact Chambers

No. of Units	2
Channels Per Unit	1
Volume Per Unit (Gallons)	68,000
Retention (minutes)	
@ Peak Hourly Design Flow Rate (10.74 MGD)	18.2
@ Avg. Daily Design Flow Rate (4.2 MGD)	46.6



Operations Building 1st Floor: Sodium Hypochlorite Feed System.

The NPDES permit also places a limit on the concentration of Total Residual Chlorine that can be discharged. Currently, operators attempt to match the chlorine dose to the chlorine demand so that the limits for E. coli (average 126 colonies/100 ml) and Total Residual Chlorine (1.0 mg/l) are both met. This means of operation has historically been problematic with achieving consistent permit compliance. Either the chlorine dose is high so that the E. coli limit is met but the chlorine residual limit is exceeded or the chlorine dose is low, so the chlorine residual limit is met but the E. coli limit is exceeded. This is demonstrated in Table 4-11, which provides a summary of the monthly average concentration and the maximum day concentration for both Total Residual Chlorine and E. coli from January 2021 to December 2024. Permit violations are highlighted in pink. One of the issues impacting this means of control is that operators are always attempting to optimize nitrogen removal to comply with the total nitrogen limit in the permit. The treatment facility is not currently designed for nitrogen removal so in spite of the operator's best efforts, partial nitrification and the formation of nitrites routinely occurs. Each mg/l of nitrite formed will consume 5 mg/l of chlorine and the resulting high chlorine demand leads to chlorine residual control problems and increased E. coli violations.

To address these issues with the disinfection system, higher chlorine doses are suggested and a means to dechlorinate the wastewater prior to its discharge should be provided.

The contact chambers were constructed in 1960. Both chambers were in service at the time of site inspections so a full assessment of the concrete could not be completed. However, no issues were reported by plant operators. During future upgrades to the WWTP, the concrete should be inspected and repaired, as necessary.

Table 4-11
 WWTP Effluent TRC and E. coli Summary (2021 – 2023)

2021				
Month	Total Residual Chlorine (mg/L)		Effluent E. Coli Concentrations (colonies/100 mL)	
	Monthly Average	Maximum Day	Monthly Average	Maximum Day
January				
February				
March				
April	0.52	0.90	483.56	2420
May	0.61	1.50	1555.50	2420
June	0.59	0.95	281.44	2420
July	0.51	1.20	922.67	2420
August	0.62	1.00	321.75	2420
September	0.59	1.27	1070.13	2420
October	0.57	1.10	1175.50	2420
November				
December				
2022				
Month	Total Residual Chlorine (mg/L)		Effluent E. Coli Concentrations (colonies/100 mL)	
	Monthly Average	Maximum Day	Monthly Average	Maximum Day
January				
February				
March				
April	0.56	1.22	322.75	2420
May	0.55	0.76	6.88	13
June	0.51	0.70	4.67	23
July	0.52	0.71	287.89	2420
August	0.46	0.89	303.33	2420
September		0.00	570.33	2420
October	0.50	0.94	361.75	2420
November				
December				
2023				
Month	Total Residual Chlorine (mg/L)		Effluent E. Coli Concentrations (colonies/100 mL)	
	Monthly Average	Maximum Day	Monthly Average	Maximum Day
January				
February				
March				
April	0.58	1.19	962.25	3610
May	0.56	1.41	1829.00	6490
June	0.54	0.83	357.50	862
July	0.56	1.40	324.75	581
August	0.52	0.99	554.80	2420
September	0.49	0.90	201.50	428
October	0.47	0.83	1451.00	3260
November				
December				
2024				
Month	Total Residual Chlorine (mg/L)		Effluent E. Coli Concentrations	
	Monthly Average	Maximum Day	Monthly Average	Maximum Day
January				
February				
March				
April	0.47	0.80	1263.75	2420.00
May	0.47	0.81	168.00	317
June	0.57	1.09	329.25	961.00
July	0.58	0.77	149.20	488.00
August	0.53	0.73	937.00	1730.00
September	0.48	0.96	29.00	44
October	0.51	0.79	80.75	122
November				
December				

Note: Shaded values exceed permit limits

4.4 SOLIDS HANDLING

Solids handling processes consists of a flow splitter box, sludge thickening and dewatering. Sludge thickening is performed in two gravity thickeners while dewatering is accomplished via a belt filter press. Scum is also collected within various process tanks (primary clarifiers, and secondary clarifiers) and is mixed and pumped along with settled sludge for processing. Dewatered sludge and scum are ultimately transported to a private incinerator for disposal.

Gravity Thickeners

Prior to entering the Gravity Thickeners, primary sludge, waste activated sludge and treated plant effluent are first directed to a splitter box consisting of a 7 by 9 by 4-foot-tall concrete structure located above the second floor of the thickener room. The primary sludge enters at a concentration of approximately 2-percent to 3-percent solids while the secondary sludge (WAS) enters within the range of ½-percent to 1-percent solids. Blended primary sludge, waste activated sludge and treated effluent are then directed to the gravity thickeners.

The gravity thickener tanks provide a quiescent settling basin for separating the liquid and solid fractions of the sludge. Thickened sludge generally contains 4-percent to 6-percent solids. Two (2) circular steel thickeners are located within the thickener room of the Operations Building. The thickeners were installed in 1976. Each tank has a diameter of 30-feet with a sidewall depth of 12.7 feet. Aside from thickening, the thickeners provide a means to store solids so that dewatering operations do not need to be conducted on a daily basis.

Collection of the primary and secondary sludge within each thickener tank is accomplished using collector arms located at the bottom of each tank that are rotated around the center of the tank, from a 0.75-Hp drive assembly, while scraping the sludge contents to a center hopper. Once the sludge is collected within the hopper, the belt press feed pumps, which are two (2) 7.5 Hp dual plunger type positive displacement pumps, convey the sludge to the Belt Filter Press (BFP). One pump is required for the operation with the duty pump rotated on a daily basis.

Gravity Thickener effluent passes over the effluent weir located on the perimeter of each tank, where it then returns to the effluent side of the Aerated Grit Chamber.

The operations building and in particular, the gravity thickeners have historically been plagued with odors and the presence of a corrosive atmosphere. The likely causes are inadequate surface overflow rates and an inefficient ventilation system (refer to Section 4.3.6). A common operating range for surface overflow rates is 400 gpd/ft² to 800 gpd/ft². To accomplish this with both thickeners in operation, treated plant effluent must be added to the thickeners at a rate of 0.5 mgd to 1 mgd. The pumping system associated with treated effluent was out of service for an extended period and therefore, adequate overflow rates were not been maintained. The pump was recently replaced. In addition, the plant's Operations and Maintenance Manual states that the Sludge Volume Ratio (SVR) should be maintained at 0.5 days to 2.0 days. The lower end of the range should be maintained during warmer weather when the risk of septicity is high. SVR is the total volume of solids in the thickeners (determined by the depth of the sludge blanket) divided by the daily solids feed rate. To achieve the appropriate SVR, a sludge blanket of 3 to four feet should be maintained. The gravity thickeners are typically operated at higher sludge blankets, which may lead to odor generation. This is beyond the control of the operators as the existing dewatering equipment is inefficient and at the end of its useful life.

Typical design solids loading rates for gravity thickeners are in the range of 6 lb/d/ft² to 10 lb/d/ft². Current solids loading rates are below thresholds.

Since the thickeners are nearly 50 years old, and have been operated in a corrosive environment, the tanks and internal mechanisms are likely in need of replacement. New thickeners should be covered to minimize the amount of air that needs to be withdrawn for odor control purposes.

Belt Filter Press

Gravity thickened sludge is pumped to a 2-meter Belt Filter Presses (BFP) for dewatering. The belt press, which has a processing capacity of 3,400 dry pounds of solids per day, was installed in 1990 and is nearing the end of its design life. With only one BFP, there is no redundancy for the dewatering process. If the BFP is out of service, operators can dispose liquid sludge (less than 6 percent solids) drawn from the gravity thickeners.

Plant operating data indicates that the belt presses achieve a final solids concentration of 15% to 25%. Dewatering efficiency is generally lower when the solids throughput is higher. Periodically, the nature of the sludge being processed also contributes to lower solids concentrations in the final product. Many factors could lead to this including septicity of the thickened sludge. It should be noted that the City's solids disposal contract with Synagro applies a surcharge to the disposal fee if the solids concentration in the dewatered sludge is less than 18-percent.

The belt press feed pumps, located on the first floor of the Gravity Thickener Room within the Operations Building, transfer sludge from the Gravity thickeners to the belt filter press. With solids generation at approximately 4,600 lb/d, the BFP is typically operated 7 hours/day, 2-3 days per week. The optimal throughput of the BFP is 2000 lb/hr to 2,500 lb/hr. Once sludge is dewatered through the BFPs, a sludge conveyor then transports the dewatered sludge to a sludge hopper, where the sludge is then discharged through the floor of the filter room and into a truck below in the sludge garage. Conveyors and other equipment are also at the end of their design lives. The corrosive atmosphere in these processing areas has accelerated the aging of the equipment.

Polymer Feed System

The polymer feed system is used to aid the dewatering process by causing the sludge solids to flocculate when contact is made between the sludge and polymer solution. The flocculation of sludge particles allows for the extraction of water through the dewatering process to be completed more efficiently. The system consists of a polymer mixing tank, polymer aging tank, and two polymer feed pumps. The polymer mixing tank is a 108-gallon tank that mixes dry, bagged polymer with water to create a polymer solution. Once mixed, the polymer solution then passes through a baffled 500-gallon stainless steel polymer mixing tank, where the detention time of the solution is increased. One of two diaphragm positive displacement metering pumps is used to convey the polymer solution through this system and to the polymer injection ring, where the solution is introduced to the thickened sludge, upstream of the BFP conditioning tank. The polymer mixing system does not function properly, so polymer is mixed manually by the operators in less exact and more time consuming manner.

4.4.1 VENTILATION AND ODOR CONTROL

The South Hadley WWTP has an odor control system intended to provide ventilation for the Sludge Loading Bay, Belt Filter Presses, and Gravity Thickeners within the Operations Building. Exhausted air can

be discharged through an activated carbon filter system that contains 10,000 pounds of carbon. The carbon filter has the ability to remove hydrogen sulfide and other odorous compounds from the air as it passes through. The system has a design flow of 11,000 cubic feet per minute (CFM). A 25-HP explosion proof fan is used to exhaust air from the building.

The air handling system appears to be inadequate as evidenced by the degree of corrosion on metallic surfaces. The activated carbon system to mitigate odors is also largely ineffective as it is spent quickly and replacement costs are high. Alternative means of odor control such as biofilters and wet scrubbers should be considered. The Town has the ability to bypass the activated carbon vessel while still removing odors from within the Operations Building, but this discharges the untreated air, leading to increased odors in the area.



Operations Building 2nd Floor: Gravity Thickener Tanks.



Operations Building 2nd Floor: Belt Filter Press

4.5 ANCILLARY SYSTEMS

This section provides an itemized discussion related to the condition of ancillary systems at the WWTP including:

- Plumbing.
- Heating, ventilation and air conditioning (HVAC).
- Electrical; and
- Instrumentation and controls.

The discussion is broken down by process area/building for each system.

4.5.1 *PLUMBING SYSTEMS*

Generally, plumbing fixtures, threaded gas pipe, copper pipe, fittings, and valves have an average lifespan of approximately 30 years. Fixtures and piping systems at the WWTP appear to be in fair condition and are nearing the end of their life expectancies. It must be noted that while the pipe exterior appears intact and continuous, the condition of the pipe interior including cleanliness, buildup of contaminants, pitting, corrosion, and thinning of the pipe walls is unknown.

Faucets and flush valves have an average lifespan of approximately 7-12 years. These appear to be in fair to poor condition and are beyond their life expectancies.

If properly maintained, cast-iron pipe can have an expected useful life of 60 years or more and the observed piping installed appeared to be in fair to good condition with no leaks observed. The piping is likely original to the building and may be nearing the end of its useful life expectancy. It must be noted that while the pipe exterior appears intact and continuous, the condition of the pipe interior including cleanliness, buildup of contaminants, pitting, corrosion, and thinning of the pipe walls is unknown.

Grit Building

- The majority of the observed drainage piping appeared to be heavy duty, cast-iron pipe and is believed to be original to the building. A sump pump is installed in a pit on the drain line in the Basement. The pipe, fittings and drains are over 45 years old according to the available documentation and appear to be at the end of their useful service life.

Digester Building

- The building is supplied from a 1-inch Domestic cold-water line.
- The existing plumbing fixtures are believed to be supplied by potable water. Plumbing fixtures used for hygienic purposes are required to be provided with potable water, whereas water distribution for process related equipment is required to be non-potable water that is separated from the potable water system with a backflow device to prevent cross contamination.
- The distribution piping appeared to be copper with soldered fittings and was not insulated. The piping is over 15 years old according to the available documentation and appears to be in fair to poor condition.
- Hot water is provided by a 10-gallon, electric type, storage water heater. Piping to and from the water heater appeared to be copper with soldered fittings and was not insulated. The piping is

over 15 years old according to the available documentation and appears to be in fair to poor condition. A thermometer and master mixing valve were not observed to be installed. These items are commonly installed for this type of service.

- Floor mounted vitreous china toilet with manual flush valve is provided in the Bathroom. Flushing capacity of this fixture was not obtained by observation.

RAS Building

- The majority of the observed drainage piping appeared to be heavy duty, cast-iron pipe and is believed to be original to the building. A sump pump is installed in a pit on the drain line in the Basement. The pipe, fittings and drains are over 45 years old according to the available documentation and appear to be at the end of their useful life.

Operations Building

- The building is provided with a 6-inch main that appears to split into dual systems, a potable water system and non-potable water system. A 4-inch backflow preventer (recently replaced) is provided downstream of the potable water to separate the two systems.
- The observed distribution piping systems do not appear to conform to current plumbing code's identification requirements. Where a building is provided with dual distribution systems; potable water systems are required to be painted green, while non-potable water systems are required to be painted yellow. For this installation, it appears the potable system is painted blue, and the non-potable system is painted orange.
- The distribution piping appeared to be copper with soldered fittings and was not insulated. The piping is over 45 years old according to the available documentation and appears to be at the end of its useful service life.
- Hot water is provided by an oil-fired water heater in the Boiler Room. There is no hot water recirculation pump or piping. Piping to and from the water heater appeared to be copper with soldered fittings and was not insulated. The age of the water heater, which appears to be approximately 10 years old, appeared to be in fair condition, although the condition of the water heater interior as regards corrosion and thinning of the vessel walls is not known. This unit is scheduled for replacement in 2026 with a gas fired heater.
- Duplex sump pumps are installed within a pit located in the Basement level. The pumps were replaced in 2024 and are in good condition. Sump pumps have an average lifespan of approximately 10 years. The piping and valves outside the pit are also in good condition.
- For emergency showers, 248 CMR 10.13(1)(l)4 & 5 requires 30 gallons per minute of 70 degree F to 90 degree F tempered water to be provided, while ANSI standards stipulate a time period of 15 minutes. The emergency showers are only connected to cold water.



Neutralization Trap

4.5.2 HEATING VENTILATION AND AIR CONDITIONING (HVAC)

Grit Building

- Building heat is provided by hot water unit heaters, which have a useful life expectancy of 15 years. The heaters are supplied by hot water piped through an underground utility tunnel from the hot water boiler in the Digester Building. The unit heaters are over 45 years old according to the available documentation and appear to be at the end of their useful life.
- Building ventilation operates off the light switch. There is a roof mounted Exhaust Fan and a corresponding roof mounted Intake Hood with connecting ductwork for both. The building ductwork shows clear signs of corrosion and lack of ventilation air. The equipment is over 45 years old according to the available documentation and appears to be beyond its useful service life.
- Wastewater Treatment Facilities fall within NFPA 820, which specifies minimum ventilation criteria. For the Grit Room the space is assumed to be unclassified, and there is no required ventilation rate as per NFPA 820 Table 6.2.2(a) Row 2. In the Pump Chamber on the Lower Level, the design ventilation rate was calculated to be equal to 3 air changes per hour.
- Hot water piping is required to be insulated per the International Energy Conservation Code.

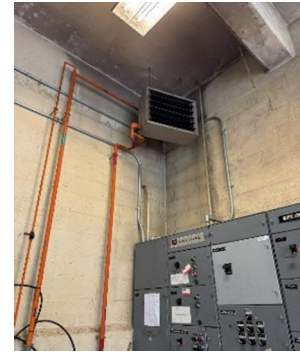

Hot Water Unit Heater

Utility Tunnel

- Building heat is supplied from the gas-fired hot water boiler in the Grit Building basement. The hot water is piped through the tunnel to Hot Water Unit Heaters in the Digester Building. The piping is not insulated.
- There is no mechanical cooling for the space and it is susceptible to moisture build-up.
- The space is ventilated via what air travels into and out of the tunnel via access openings at either end.
- The average lifespan of steel pipes, fittings and valves is about 50 years under typical building service conditions. Copper pipes, fittings, and valves have an average lifespan of approximately 30 years. The installed piping is over 45 years old according to the available documentation and appears to be in fair condition, but the conditions of the pipe interior and wall thickness are not known. In addition, the piping is required to be insulated according to the International Energy Conservation Code.



Utility Tunnel

Digester Building

- A gas-fired hot water boiler located on the first floor, provides hot water for unit heaters and finned radiation in this building and the Grit Building. Supply and return piping runs from the Digester Building through an underground utility tunnel to supply unit heaters in the Grit Building. The boiler appears to be over 25 years old and at the end of its useful life. The hot water piping is not insulated.

RAS Building

- Building heat is provided by electric unit heaters. The heaters are over 45 years old according to the available documentation and appear to be beyond their expected service life. The heater on the first floor is inoperable.
- Building ventilation is operative. There is a roof mounted Exhaust Fan and a corresponding roof mounted Intake Hood with connecting ductwork for both. The building ductwork shows clear signs of corrosion and lack of ventilation air. The fan and intake hoods are over 45 years old according to the available documentation and appear to be beyond their expected service life.
- Wastewater Treatment Facilities fall within NFPA 820, which specifies minimum ventilation criteria. For this facility, there is no standard ventilation rate used for a Sludge Pumping Station Dry Well per NFPA 820 Table 6.2.2(a) Row 9 line a. In the Lower Chamber, the design ventilation rate was calculated to be equal to 11 air changes per hour. Since the equipment is not operating, the lack of ventilation employed in this facility is manifesting itself in the advanced state of deterioration showing in the HVAC equipment.

Operations Building

- Building heat is provided by gas-fired hot water boilers. From the boilers, hot water is piped throughout the building and circulated via centrifugal pumps located in the Boiler Room. Hot water is piped to finned radiation and unit heaters. The piping is insulated at the boilers but not in the open room spaces. The boilers are over 25 years old and appear to be at the end of their expected useful life.
- A Rooftop AC unit with an indoor air handler serves the administrative spaces. Cooled air is ducted from the AC units to ceiling mounted supply diffusers throughout the space. This equipment is over 15 years old according to available documentation and is reported to be leaking condensate.
- The Lab contains an exhaust hood and ductwork. The hood is functional.
- Wastewater Treatment Facilities fall within code NFPA 820, which specifies minimum ventilation criteria. For these spaces, the Filter Room is assumed to be Class 1 Division 1, the electrical equipment in the room is explosion proof and there is no minimum air change requirement. In the Thickener Room, a clearance above water surfaces and a 3-foot horizontal separation from walls allows no or reduced ventilation from the space. A preliminary tabulation of the exhausted volume vs the fan capacity indicates the volume exhausted (Filter Room plus Thickener Room) is 151,995 cubic feet while the fan is exhausting 11,012 cubic feet per minute of air. This results in a calculated Air Change volume of 4.3 air changes per hour from the two rooms.

4.5.3 ELECTRICAL

The facility receives 480 Volt, 3-phase, 3-wire, 800 Amp utility power from a pad mounted utility transformer located along the end portion of the facility's driveway. The utility transformer's primary lines originate overhead from a utility pole located at the facility's entrance and enter into the transformer via an underground duct bank. The transformer's secondary power feeds into the facility's main distribution switchboard located in the Operations Building via an underground duct bank. The facility is utility metered via secondary metering compartment within the main switchboard.

Power is transferred from the transformer to MCC-1 located in the Chemical Storage Room of the Operations Building. MCC-1 distributes power to MCC's 2 through 4 and also houses the Automatic Transfer Switch and controls for transferring the WWTP's power source to the emergency standby generator in the event of power loss at the facility. MCC-2 is located on the second floor of the Operations Building and houses the controls, motor starters, alarms, and instrumentation for all equipment located in the Operations Building. MCC-3 is located on the upper level of the Return Sludge Pump Station and houses the variable speed controllers for the RAS and WAS Sludge Pump and the controls for other equipment within and around the Return Sludge Pump Station. MCC-4 is located on the upper level of the Grit Building which is used to distribute power to the small MCC within the old Control Building. MCC-4 contains circuit breakers and control circuitry for the Grit Blowers, primary pump equipment, and mechanical aerators.

- The main distribution switchboard houses an 800 Amp main circuit breaker, an 800 Amp automatic transfer switch (ATS), a digital meter, a surge protector, and seven distribution power circuit breakers. Three circuit breakers are used for feeders and the remaining four are spares. The main switchboard is less than 5 years old and is in good condition.
- The facility receives back-up power from a new 350 KW, natural gas fired engine generator located inside the Generator Room of the Operations Building. The generator feeds into the switchboard automatic transfer switch.



Generator

Grit Building and Pipe Gallery

- The Grit Building motor control center MCC-4 is a 277/480 Volt, 4-phase, 4-wire, 600A motor control center that contains a 500 Amp main circuit breaker, feeder circuit breakers, motor starters, 10KVA transformers, and a 120/208 Volt panelboard "D". The MCC is located in the Grit room of the building, is over 45 years old, and in fair condition.
- The 120/208V panelboard "D" located in MCC-4 is over 45 years old and is in fair condition. The panelboard provides power branch circuit power to the building's receptacles, lights, and small mechanical equipment.
- There are general use receptacles located on the walls of the building that appear to be original to the building construction and are over 40 years old.
- There is a 10KVA, 480/120/208V, 3-phase dry type transformer that provides power to the 120/208V D panelboard, it appears to be over 45 years old and in fair condition.
- There were eight (8) Variable Frequency Drives (VFDs) located in the sludge pump chamber which is a Class I Div. 2 electrical hazardous location due to lack of air changes. The four VFDs for the surface aerators were replaced in the past two years. Other VFDs appear to be more than 20 years old, are in fair condition, and are not rated for a Class I Div. 2 area. These VFDs have been relocated to a new and separate electrical room on the upper level.
- The Grit room light fixtures consisted of pendant mounted linear industrial fluorescent type light fixtures that were replaced in 2018. The pump chamber and Pipe Gallery light fixtures consisted of pendant mounted linear lensed fluorescent type light fixtures. Lighting in the Pipe gallery does not work.

- Battery lighting units provide code required emergency egress lighting. There were no exit signs observed.
- The building did not appear to have any fire alarm or communication systems.
- The exterior of building egress doors do not have emergency lighting.
- Panelboards are considered past their useful life after 40 years due to their circuit breakers that have trip elements which tend to deteriorate over time and use and may not consistently cause a trip during a short circuit event. The panelboard in the building are over 30 years old and there is an uncertainty that their circuit breakers would trip when required and cause a life safety issue or possibility of a fire.

Digester Building

- The Digester Building panelboard PPDB is a 120/208 Volt, 4-phase, 4-wire, 225A panelboard that contains a 175 Amp main circuit breaker and feeder circuit breakers. The panelboard is located in the upper level of the building, is approximately 15 years old, and is in good condition.
- The 120/208V panelboard LPDB is approximately 15 years old and is in good condition. The panelboard provides power branch circuit power to the building's receptacles, lights, and small mechanical equipment.
- There are general use receptacles located on the walls of the building that appear to be original to the building construction and are over 40 years old.
- Motor starters for the two primary scum pumps and the primary scum grinders are located in the building lower level. This area is a Class I Div. 2 electrical hazardous location due to lack of air changes. The motor starters appear to be approximately 15 years old, are in good condition, but are not rated for a Class I Div. 2 area.
- The building did not appear to have any fire alarm systems.
- The building does not have illuminated exit signs.

RAS Building

- The Sludge Pump Station motor control center MCC-3 is a 277/480 Volt, 4-phase, 4-wire, 600A motor control center that contains a 270 amp main contactor, VFDs, motor starters, 10KVA transformers, and a 120/208 Volt panelboard "C". The MCC is located in the upper level of the building, is over 45 years old, and in fair condition. Motor control centers are considered past their useful life after 20 years since they are primarily comprised of motor starters which have multiple parts, which after 20 years are very hard to replace when a failure occurs.
- Panelboards are considered past their useful life after 40 years due to their circuit breakers that have trip elements which tend to deteriorate over time and use and may not consistently cause a trip during a short circuit event. The panelboard in the building are over 30 years old and there is an uncertainty that their circuit breakers would trip when required and cause a life safety issue or possibility of a fire.
- VFDs are considered past their useful life after 15 years due to constant increases in VFD technology and after 15 years, are parts are very hard to replace when a failure occurs. The VFDs,

which were upgrade in 2009, are over 15 years old and have hit their useful life expectancy. They will still function properly but replacing parts for future failures will be difficult and costly. One VFD was recently replaced.

Operation Building

- The Operations Building motor control center MCC-2 is a 277/480 Volt, 4-phase, 4-wire, 600A motor control center that contains VFDs, motor starters, two 30KVA transformers, and two 120/208 Volt panelboards "A" and "B". The MCC is located in the Dewatering Room of the building, is over 45 years old, and in poor condition due to excessive moisture and corrosive environment.
- The 120/208V panelboards "A" & "B" located in MCC-2 are over 45 years old and is in poor condition. The panelboards provide power branch circuit power to the building's receptacles, lights, and small mechanical equipment.
- There are general use receptacles located on the walls of the building that appear to be original to the building construction and are over 40 years old.
- There are two 30KVA, 480/120/208V, 3-phase dry type transformers that provides power to the 120/208V C panelboard, it appears to be over 45 years old and in fair condition.



MCC-2

4.5.4 INSTRUMENTATION AND CONTROLS

The plant's SCADA control system front end is located in the office area of the Operations Building. Front end equipment consists of a main rack style control panel and a SCADA computer utilizing Wonderware Version 10.0 human machine interface (HMI) software. The main control panel utilizes an Allen Bradley Control Logix PLC. The PLC communicates via an Ethernet fiber optic network to remote I/O modules located in PLC control panels in the RAS Building and Grit Building. This PLC is the main control and monitoring for treatment facility. The PLC communicates with the IFIX HMI software via an Ethernet driver. There are two Remote I/O (RIO) control panels located in the plant. RTU-1 is located in the Grit Building, while RTU-2 is located in the Sludge Pumping Building.

- The SCADA control system as a whole is convoluted with two separate PLC platforms. The system does not have redundant PLC processor if the main PLC processor was to fail, which is common for PLC system in wastewater.
- This system's remote I/O modules are approaching their useful life of 20 years. These modules (Legacy) are no longer being manufactured.

Plant Water System

The Plant Water System begins after the backflow preventer on the potable (Town) water line in the southeast corner of the workshop in the operations building. It is used generally for wash-down and clean-up purposes. It feeds many hose bibs throughout the operations building, serves as make-up water to the polymer system mix tank. A one inch in diameter branch leaves the operations building from the

northwest corner of the sludge garage and travels underground to the return sludge pump station. There it supplies hose bibs, a slop sink and provides seal water to the return and waste sludge pumps.

A similar but smaller plant water system begins after a 2½" backflow preventer in the southeast corner of the basement of the digester control building. This system supplies hose bibs around the digester control building, tunnel, grit building and primary pump chamber.

Treated (Plant) Effluent System

The WWTP Treated Effluent Pump System delivers non-potable, chlorinated Secondary Clarifier effluent to the facility's, gravity thickeners, grit bucket elevator, belt filter press, and yard hydrants. The system consists of the following components:

- Two valved 6" inlet pipes, one from each chlorine contact chamber to the plant effluent water well.
- Two 6-inch knife gates.
- A 4' in diameter by 8' deep plant effluent water well which serves as the holding tank for the plant effluent water to be pumped.
- A plant water pump pit which is a precast concrete structure located underground at the south end of the chlorine contact chamber.
- One 30 HP vertical turbine type pump (installed in March 2025) capable of delivering 325 gpm at a total dynamic head of 235 feet.
- Valves and piping to carry the pumped discharge to the strainer in the workshop of the operations building.
- An automatic strainer with associated valves and controls.

5.0 FUTURE CONDITIONS

For wastewater facilities planning purposes, future conditions within the 20-year planning period are defined so that wastewater management alternatives may be evaluated using appropriate parameters. These conditions, which include residential development and population increases, and industrial and commercial development, will determine where sewer system expansion will occur and define future flows and pollutant loads to the treatment facility. The analysis of future residential and commercial/industrial development is based on the findings of the South Hadley’s 2020 Master Plan (MP), Open Space and Recreation Plan (OSRP), and 2016 Housing Production Plan (HPP). Similar evaluations were conducted in Granby and Chicopee as both discharge a portion of their wastewater to the South Hadley.

5.1 POPULATION AND DEMOGRAPHIC PROJECTIONS

To determine the projected future wastewater flows that are to be generated within the Town of South Hadley, it is necessary to estimate planning year population figures. In addition, conditions must be evaluated to develop a basis for the proper sizing of interceptor sewers, treatment facilities and other appurtenances which have useful lives far in excess of the 20-year planning period through 2045.

Based on South Hadley’s Master Plan, the population in South Hadley is expected to increase by 2.5% over the next ten years, which would result in a population of 18,604 by 2030. This projection for the future population is less than the increase in South Hadley’s population that occurred from 2010 to 2020, which increased by 3.6% as recorded by the United States Census Bureau. However, the population projection for South Hadley, as prepared by the Population Estimates Program (PEP) through the University of Massachusetts Amherst Donahue Institute (UMDI) show the population decreasing by 0.1% to 18,128 through the year 2045. Table 3-1 depicts UMDI’s population projections for the Town of South Hadley. For purposes of this planning effort, South Hadley’s population is expected to remain at its present level.

Table 5-1
Population Projections through 2045 (UMDI)

Year	Population
2020*	18,150
2025	18,207
2030	18,276
2035	18,208
2040	18,214
2045	18,128
*U.S. Federal Decennial Census.	

5.2 FUTURE LAND USE & DEVELOPMENT

The Town of South Hadley is predominantly zoned as Residential and Agricultural. A small area in the southern portion of the Town along the Connecticut Rive is zoned as Business and Industrial. One of the three highest priorities of the Master Plan includes addressing community-wide housing needs. South Hadley lacks diverse housing options where a majority of the housing stock is single-family residential. As a result of this, South Hadley does not meet the state-mandated 10% affordable housing requirement. To

meet this requirement, South Hadley needs to incorporate an additional 313 affordable units to the existing housing stock. To accommodate this requirement, the Town’s 2016 Housing Protection Plan (HPP) has evaluated nine locations for potential development opportunities and six (6) locations for potential redevelopment opportunities. Of the fifteen (15) potential locations, one location is located outside of the existing sewer service area. Potential development areas are summarized below:

New Development Opportunities	
<u>Location</u>	<u>Development Restraint</u>
“Toth” Property – 22.1 Acres	Wetlands
“SHELD” Property – 7.51 Acres	Potential for SHELD to use property as new office
“Polish American Club” Property – 19.86 Acres	Wetlands / Business A-1 Zoning
“Hospital” Property – 24.70 Acres	Wetlands / Business A-1 Zoning
“South Hadley Square and environs” Property – 23.8 Acres	Wetlands / Special Zoning
“East Street” Property – 12 Acres	Site cleaning / further evaluation needed
“Alvord Street” Farm Property	Community not in favor of future development
“Marina” Farm Property – 50 to 70 Acres	Community not in favor of future development
“Hadley Street” Open Space – 100 Acres	Town sewer/water not available in area

The northern third of the Town, which is largely undeveloped, consisted of protected open space either through the State’s Department of Conservation and Recreation or the Town’s Conservation Commission.

5.3 FUTURE FLOWS AND LOADS

As evaluated in Chapter 2, there are approximately 130 properties in South Hadley that are in areas that may be problematic for the use of septic systems. These properties were identified in previous wastewater planning efforts but have not been connected to the sewer system to topographical influences and the high construction cost relative to the number of homes served. Although sewer extensions are unlikely, they are carried in this planning document. If sewer, the 130 homes will contribute approximately 25,000 gallons of wastewater on an average day basis to the South Hadley collection system.

As discussed in the Housing Protection Plan, the Town needs to develop 313 units to accommodate the affordable housing requirement, which will most likely be completed through infill development and redevelopment of under-utilized sites. This will result in the future units being developed in areas where the existing sewer infrastructure already exists. These 313 housing units will generate approximately 60,000 gallons of wastewater on an average day basis.

5.3.1 *FLOW FROM GRANBY*

Granby’s Comprehensive Wastewater Management Plan recommended expansion of their wastewater collection into the Town Center Area, which would contribute wastewater to South Hadley. The estimated average daily wastewater contribution is 57,200 gpd. According to officials from Granby, they would like to see the sewer collection system expanded to the Town Center but there is no plan in place. Expansion of sewer to this area would help cut costs associated with the Town’s Fire, Police, and Town buildings that

are currently served by septic systems. If this expansion were to take place, the Intermunicipal Agreement with South Hadley may need to be re-negotiated.

5.3.2 FLOW FROM CHICOPEE

Representatives from the City of Chicopee did not identify any areas for sewer system expansion in the region that connects into South Hadley. Therefore, the average daily wastewater flow stipulated in the Intermunicipal Agreement with South Hadley is satisfactory. Based on the 150,000 gallons per day allowed by the Intermunicipal Agreement with South Hadley, and the current average daily of 45,000 gpd, Chicopee could contribute an additional 105,000 gallons per day.

5.3.3 FLOW AND LOAD PROJECTION

As presented in Section 4. 2, the current average daily wastewater flow to the WWTP is 3.05 mgd. This includes all wastewater generated in Chicopee and Granby. Additional flow from South Hadley, Granby and Chicopee are estimated at 85,000 gpd, 57,000 gpd and 105,000, respectively. This will bring the future average daily flow to the South Hadley WWTP to approximately 3.3 mgd, which is well below the facility design flow of 4.2 mgd.

The corresponding average daily increase in the mass of BOD₅, total suspended solids and Total Kjeldahl Nitrogen are estimated at 520 lb/d, 610 lb/d and 75 lb/d, respectively. Projected average day and maximum monthly flow and loading rates are shown in Table 5-2. These flow and loading rates are below the design values of the treatment facility.

Table 5-2
 Projected Average Day and Maximum Monthly Flow and Loading Rates

<u>Parameter</u>	<u>Average Day Loading, lb/d</u>	<u>Maximum Monthly Loading, lb/d</u>
Flow, mgd	3.3	5.3
BOD ₅ , lb/d	3,220	5,040
TSS, lb/d	4,500	11,000
TKN, lb/d	840	1,100

6.0 EVALUATION OF TREATMENT ALTERNATIVES – WWTP UPGRADES

6.1 DISCHARGE PERMIT AND FLOW CONSIDERATIONS

This chapter presents the results of the evaluation of the existing WWTP and its ability to handle the projected flows and pollutant loads that were presented in Table 5-2. Based on the flow analysis discussed above, expansion of the South Hadley WWTP to increase treatment capacity is not necessary. Accordingly, no changes to the limits in the NPDES permit are anticipated.

Necessary plant improvements discussed in this chapter focus on three areas:

1. Improvements needed to comply with the total nitrogen limit established in the Town's NPDES permit.
2. Improvements needed to comply with effluent Total Residual Chlorine and Escherichia Coli limits established in the Town's NPDES permit.
3. General improvements to upgrade other treatment processes, and ancillary building systems that are aging or in poor condition.

The objective in evaluating alternatives is to utilize existing facilities to the maximum extent possible, minimize structural modifications, and provide cost-effective solutions.

Cost estimates included in this chapter include both capital costs and additional operation and maintenance costs resulting from the construction of new processes. Capital costs include construction costs for process equipment, structures, auxiliary equipment, piping, electrical, instrumentation, control systems, and allowances for contingencies, engineering, and project administration. Costs were determined through several methods including quotations from equipment suppliers, recent construction experience on similar projects, and published information on construction costs. All costs are referenced to an Engineering News Record (ENR) Index of 18,576 (Boston, October 2025).

Annual operation and maintenance costs for the additional processes include factors such as labor, chemicals, energy and maintenance. Labor costs were derived from estimated man-hours required on a weekly basis for maintenance of the systems that require special attention. Chemical costs were based on the average dosage of chemical applied to the wastewater at the design average day loading rate to the facility. Actual costs of the chemicals were based on information obtained from local suppliers. Energy costs for equipment operation were determined by using the average power draw for the equipment, number of service hours for the equipment and local electricity costs estimated to be \$0.15 per kilowatt-hour.

A project service life of 20 years was assumed, and all funding was through the Clean Water State Revolving Fund (CWSRF) at an interest rate of 2-percent. Additional discussion on financing is included in Chapter 7.

6.2 ALTERNATIVES TO REMOVE NITROGEN

6.2.1 *MODIFIED LUDZACK ETTINGER (MLE) PROCESS*

The secondary treatment process (suspended growth activated sludge) at the South Hadley WPCF was originally designed for BOD removal only. The effluent from the primary clarifiers flows to one of two aeration basin trains where each train incorporates two aeration tanks. Each tank is equipped with a mechanical surface aerator that is designed to mix the contents of the tank and simultaneously transfer

oxygen from the atmosphere into the liquid, creating aerobic conditions within each tank. Aerobic bacteria remove BOD by consuming organic matter in wastewater in the presence of oxygen. These microorganisms break down organic pollutants into simpler substances like carbon dioxide and water. For BOD removal, approximately 1.2 pounds of oxygen is needed to remove 1 pound of BOD.

The current NPDES permit that governs the treatment facility imposes a year-round, mass-based total nitrogen limit of 350 pounds per day, which is equivalent to 10 mg/l at the 4.2 mgd design flow. Since the projected average daily flow to the treatment facility will remain below design levels, the mass limit allows a slightly higher concentration of total nitrogen to be discharged.

To promote nitrogen removal is a suspended growth process, ammonia in the wastewater must first be converted to nitrates, or nitrified, under aerobic conditions. This can be accomplished in the same basins where BOD is removed but additional oxygen is required and slightly longer hydraulic residence times are preferable. Approximately 4.6 pounds of oxygen is needed to nitrify one pound of ammonia. When subjected to anoxic conditions, bacteria use the oxygen attached to the nitrate molecule as their oxygen source, which converts nitrates to nitrogen gas that is released to the atmosphere.

The MLE process places an anoxic zone ahead of the aerobic portion of the biological reactor, as shown in the process schematic provided as Figure 13. Primary effluent enters the anoxic zone along with return activated sludge and an internal recycle stream from the aerobic zone. Denitrification occurs in the anoxic zone and nitrification takes place in the aerobic zone. Primary effluent serves as the carbon source and nitrates in the recycle streams supply the oxygen required to support the microorganisms responsible for denitrification. In practice, 4 to 6 pounds of BOD are necessary to remove one pound of nitrate-nitrogen. when influent wastewater is used as the carbon source. Due to the relatively low concentrations of BOD South Hadley's influent wastewater, a supplemental carbon source may be needed. The recycle rate from the aerobic zone to the anoxic zone is typically two to four times the influent flow rate, but is dependent on the concentration of nitrates produced in the aerobic zone and the targeted total nitrogen concentration. The MLE process is generally applicable to treatment facilities with a total nitrogen limit of 8 mg/l or higher.

To incorporate the MLE process at the South Hadley WWTP, the first basin in each treatment train will be converted to an anoxic zone. The basin would be divided in half with the first half operated in an anoxic mode and the second half operated as a swing zone that could be operated under anoxic or aerobic

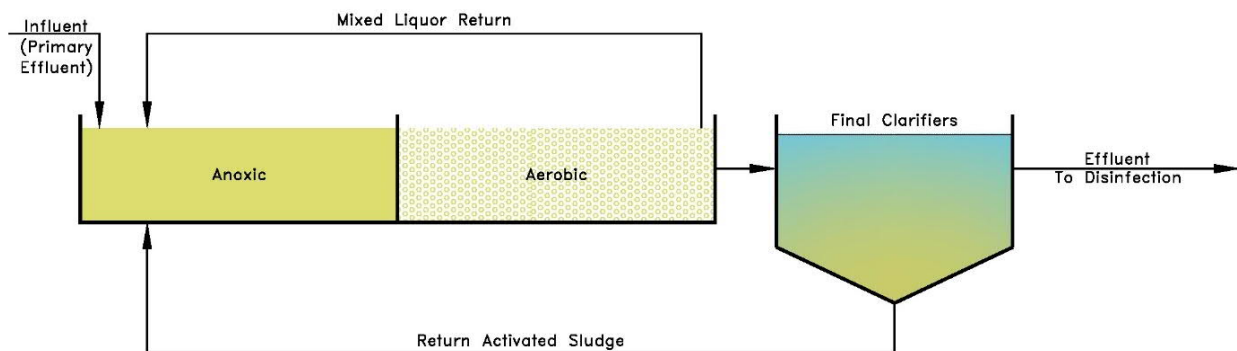

Figure 13: MLE Process Schematic

conditions. To accomplish this, walls would be constructed at the at the midpoint of the basin to divide separate the anoxic and swing zones, and at the ¼ point to further divide the anoxic zone into two passes. Walls would extend from one end of the tank to approximately 4 feet from opposite perimeter wall to allow flow to pass. These tank modifications will require the existing surface aerators to be removed. Submersible mixers would be placed in the two anoxic passes to keep the solids in suspension. The swing zone would be fitted with both submersible mixers for anoxic control and fine bubble diffusers for aerobic operation. This provides operations personnel the flexibility to manage the treatment process under various loading and temperature conditions. Since nitrogen removal is required year-round, wastewater temperatures can vary from 10°C to 25°C. Biological processes slow under colder temperatures, so additional residence under aerobic conditions may be needed to promote nitrification. Process modifications also include replacement of the surface aerators in the second aeration basin with a fine bubble, diffused air system. This will require a series of blowers to provide a total of approximately 2,200 SCFM of air to the aerobic basins under projected average day flow and loading conditions.

Typical design parameters for the MLE process, as presented in TR-16, are provided in Table 6-1. Since each existing aeration basin has a volume of 375,000 gallon, the modifications discussed above will result in an aerobic zone hydraulic retention time of 4.3 hours with the swing zone operated under anoxic conditions and 6.42 hours with the swing zone operated under aerobic conditions. These times, which were calculated at the 4.2 mgd plant design flow, are within the range of design values. Similarly, the hydraulic retention time in the anoxic zone will be 2.1 hours and 4.2 hours with the swing zone operated under aerobic conditions and anoxic conditions, respectively. Implementation of the MLE process at the South Hadley WWTP was modeled in Biowin™ (Version 6). The model was run at both the projected average day and maximum month influent conditions presented in Table 5-2 and wastewater temperatures of 10°C and 20°C. The results, which are presented in Appendix B, demonstrate that at 10°C, the process can achieve effluent total nitrogen concentrations of 9.3 mg/l and 6.4 mg/l and under average day and maximum month conditions, respectively. At 20°C the effluent concentrations drops to 8.7 mg/l and 5.5 mg/l under average day and maximum month conditions, respectively. Therefore, permit compliance will be achieved. It should be noted that the model did not include the introduction of a supplemental carbon source. However, the model produced better results under maximum month conditions because there was more carbon in the wastewater.

Table 6-2 provides an opinion of probable project costs to convert the biological treatment process to a MLE configuration.

Table 6-1
 Typical Design Parameters – MLE Process

Parameter	Typical Design Value
Hydraulic Retention Time, hours	
Anoxic Zone	1 - 3
Aerobic Zone	4 - 8
MCRT, days	6 - 12
MLSS Concentration, mg/l	2000 - 4000
Nitrate Recycle, % of influent	200 - 400
RAS Recycle, % of influent	50 - 100
Effluent TN, mg/l	8 - 10

Table 6-2
 Opinion of Probable Project Cost – MLE Process

Capital Improvement	Cost (\$)
Tank Modifications	360,000
Demolition of Surface Aerators	40,000
Submersible Mixers, Recycle Pumps and Piping	600,000
Blowers, Diffusers, New Air Piping, Instrumentation	2,100,000
Influent Channel Modifications	100,000
Subtotal	3,200,000
Engineering and Contingency (45%)	1,440,000
Total Project Cost	4,640,000
Additional Annual Operations and Maintenance Cost ¹	----

1. Likely cost decrease due to the energy savings associates with fine bubble diffused air versus surface aerators.

6.2.2 CYCLICAL NITROGEN REMOVAL (CYCLICAL AERATION)

An alternative method of nitrogen removal to the MLE process is to create alternating aerobic and anoxic phases within the biological treatment basins. Alternating aerobic and anoxic phases can be achieved in a continuous-flow, activated sludge system by cycling the aeration devices “on” and “off”. This type of intermittent or pulsed aeration in an activated sludge facility is termed cyclical nitrogen removal (CNR). Turning aeration equipment off within an aerobic basin will naturally create anoxic conditions. When the nitrates are completely depleted, aeration can be turned back on to remove ammonia and BOD. As the aeration phase continues the nitrate concentration within the basin will slowly increase until it is time to turn off the aeration system again. The CNR process has been demonstrated to produce a total nitrogen effluent concentration of <10 mg/L and, with attention to operating conditions, can consistently achieve TN levels of 8 mg/l. This may require the ability to step feed especially in warmer weather, to provide a carbon source for denitrification.

CNR typically requires only minor process modifications, particularly where there are no projected increases in design flow and pollutant loads. These modifications may be as minimal as installing timers to cycle aeration equipment. Thus, potential cost savings can be expected by implementing a CNR process when compared to other processes that may require structural modifications.

To create these conditions at the South Hadley WWTP, the existing surface aerators would be operated at high speed during the “on” cycle to entrain air (oxygen) into the wastewater and at a lower speed during the “off” cycle to promote mixing only. However, even at low-speed operation, the water surface is still disturbed allowing air to mix into the wastewater. This will lower the efficiency of the denitrification process during the anoxic phase. Therefore, it is recommended that the surface aerators be replaced with hyperbolic mixer/aerators consisting of a submersed hyperbolic mixer fitted with a coarse bubble sparge ring beneath it. The sparge ring would be fed with air from a new blower. As the mixer rotates, it chops the coarse bubbles into fine bubbles and disperses them throughout the basin. During the aerobic phase both the mixer and the blower will operate to achieve a dissolved concentration of 2 mg/l. During the

anoxic phase, the blower will be turned off and only the mixer will operate so the content of the basin remains mixed.

One of the key design parameters is the food to microorganism ratio (F/M ratio). Published literature suggests that a lower operating F/M ratio closer to 0.1 will permit a mixed biological culture for both nitrification and denitrification. The F/M ratio for a conventional activated sludge process is typically 0.15 to 0.2. On-off cycle times are dependent on the amount of nitrogen that has to be removed from the system and the wastewater temperature as reaction rates slow as the temperature decreases. Over a 6-hour cycle, the "on" times is approximately 4 hours with an "off" time of 2 hours. Since there are two aeration basins in each treatment train, the on/off cycles in each train would alternate.

Process instrumentation is typically used to target the most optimal times to engage or disengage the aeration system. Oxidation reduction potential (ORP) and ammonia/nitrate probes are the most common instrumentation to use for cyclical aeration control. During the aerobic periods, DO probes are used to control the blowers to keep the residual oxygen within a set range of 1 to 2 mg/L. Once the aerators are turned off, ORP probes are utilized to determine when the nitrates have been completely depleted, which is when the blowers are turned back on.

There are some downsides to cyclical aeration control. Designating a portion of the day to anoxic time will reduce the time available to remove BOD and ammonia. Thus, the same amount of oxygen must be induced into the system during a shorter timeframe, which requires more installed aeration power. To completely nitrify the wastewater, a specific amount of aeration time must be provided. Increasing the solids retention time (SRT) can make up for the reduction in aerobic time.

Implementation of CNR at the South Hadley WWTP was modeled in Biowin™ (Version 6). The model was also run at both the projected average day and maximum month influent conditions presented in Table 5-2 and wastewater temperatures of 10°C and 20°C. The results, which are presented in Appendix B, demonstrate that at 10°C, the process can achieve effluent total nitrogen concentrations of 11.4 mg/l and 8.7 mg/l and under average day and maximum month conditions, respectively. At 20°C the effluent concentrations drops to 11.3 mg/l and 8.2 mg/l under average day and maximum month conditions, respectively. It should be noted that the model did not include the introduction of a supplemental carbon source. However, as with the MLE process, the model demonstrates that better performance is achieved with the higher amount of carbon present under maximum month conditions. Although the model demonstrates that an effluent concentration of 10 mg/l will not be achieved, under average conditions, the mass of nitrogen in the effluent under projected average day conditions (313 lb/d) will be less than that allowed by the permit (350 lb/d).

Table 6-3 provides an opinion of probable project costs to convert the biological treatment process to a CNR configuration.

Table 6-3
 Opinion of Probable Project Cost – Cyclical Aeration

Capital Improvement	Cost (\$)
New Mixer/Aerators/Blowers/Instrumentation	1,630,000
Demolition of Surface Aerators	40,000
Influent Channel Modifications	100,000
Subtotal	1,770,000
Engineering and Contingency (45%)	800,000
Total Project Cost	2,570,000
Additional Annual Operations and Maintenance Cost ¹	----

1. No increase in annual operations and maintenance cost is expected.

6.2.3 SEPARATE STAGE DENITRIFICATION FILTERS

Deep bed denitrification filters that remove nitrogen and solids are a proven technology for treating wastewater to meet low total nitrogen limits. At the South Hadley WWTP, existing biological treatment system, which provides BOD removal and nitrification, would be maintained and the filters added to treat the nitrified effluent, prior to disinfection. Since the filters are located downstream of biological aeration basins, most of the organic material is oxidized, and some organic material must be added to the filter influent to sustain the growth of the denitrifiers. The carbon source most often selected is methanol, which is readily degraded under anoxic and aerobic conditions. Other carbon sources can also be used in denitrifying filter systems.

Denitrification filters work by filtering wastewater through deep beds of porous, granular material. Two denitrification filter configurations are available: downflow filters and upflow continuous backwash filters. Downflow filters operate in a conventional filtration mode and consist of gravel and sand media supported by an underdrain. Wastewater enters the filter over weirs located along the length of the filter bed on both sides. Filter effluent is conveyed from the bottom of the filter into a clearwell (a reservoir for storing filtered water). The filters must be taken out of service periodically for backwash and nitrogen release cycles.

Upflow filters differ in that influent wastewater flows upward through the filter countercurrent to the movement of the sand bed. Wastewater enters an upflow filter at the top and is conveyed downward through a feed pipe and distributed to the filter bed through feed radials. After traveling upward through the media, effluent wastewater is removed at the top of the filter. Due to the configuration of upflow filters, backwash is continuous, eliminating the need for separate backwash pumps. However, the volume of backwash water generated in upflow filters is typically twice that of downflow filters.

Although both types of denitrification filters are viable, downflow filters would be the suggested configuration in South Hadley. The smaller backflow rate with downflow filters will result in a lower treatment cost. Upflow filters are also constructed in smaller modules compared to downflow filters. Therefore, a greater number of filter cells are required to provide the necessary surface area to maintain design surface overflow rates.

A downflow denitrification filter contains an inert media onto which the microorganisms responsible for denitrification attach. Nitrified wastewater from the existing biological treatment process would be introduced to the top of the filter and allowed to flow down through the media. As previously mentioned, the carbonaceous component (BOD) of the wastewater is too low to support the growth of microorganisms, an external carbon source must be added. If methanol is used, the typical dosage rate is 3 pounds or 0.45 gallons per pound of nitrate to be nitrified. That is why the most common application of denitrification filters is a polishing step following a preliminary denitrification process such as the MLE process. Removing some of the nitrates before the filters reduces chemical costs. Microorganisms use the external carbon source as food and the nitrites and nitrates as a source of oxygen. The nitrites and nitrates are converted to nitrogen gas. A process flow diagram for a downflow denitrification filter is shown in Figure 14.

Figure 14
 Process Flow Diagram of Separate Stage Denitrification Filters

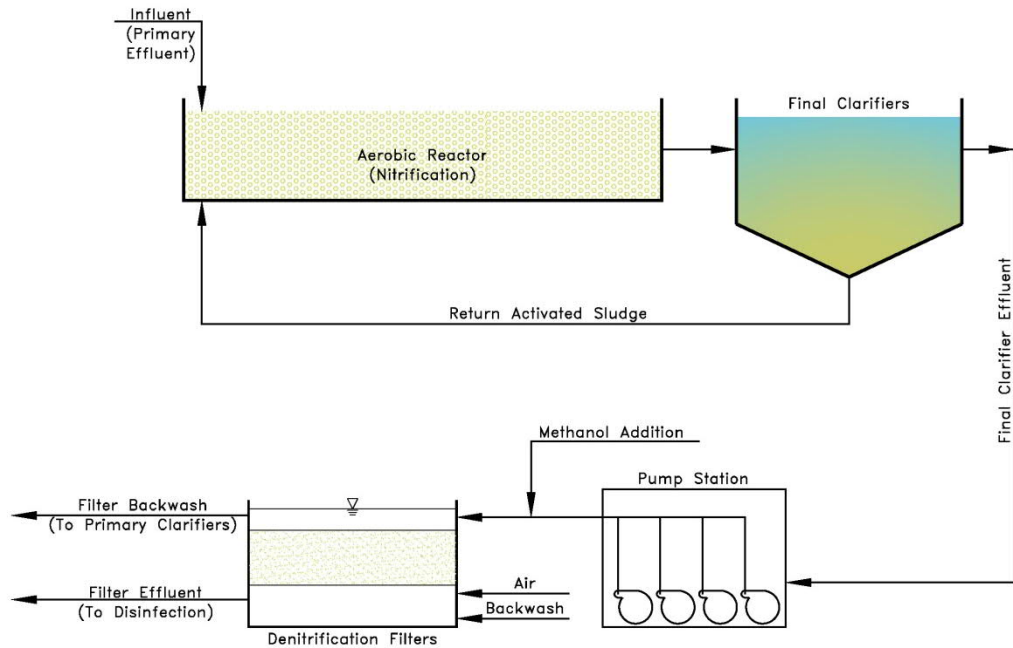

With methanol costs ranging from \$1.50 to \$2.00 per gallon, the expected annual methanol costs will range from \$150,000 to \$200,000 per year, based on expected yearly usage to lower total nitrogen concentration to less than 10 mg/l.

The granular media in the downflow denitrification filter also provides filtration and clarification for solids removal. Backwashing is used to cleanse the media of any particles that accumulate on the media. Backwashing is accomplished by pumping liquid and/or air through the media in the opposite direction of the normal flow of wastewater. The typical backwash rate is less than two percent of the plant's forward flow rate. The backwash liquid is recycled to head of the wastewater treatment facility. Any nitrogen gas that forms and becomes trapped in the media is also removed during backwashing and is released to the atmosphere.

Denitrification filters are hydraulically loaded at an average rate of 1.5 to 3.0 gpm/ft². Typical peak hourly loading rates may approach 5.0 gpm/ft². Loading rates are dependent on wastewater composition and temperature. Lower loading rates are required at lower wastewater temperatures because biological activity decreases. Based on these loading rates, approximately 1,500 square feet of filter surface area is needed to treat the design flow rate of the South Hadley WWTP. For purposes of this discussion, six 392-square-foot filters (48.5 feet long by 8.1 feet wide) would be provided to handle the proposed design conditions. Five filters would be in service with one offline. A site plan showing the location of the additional aeration tanks and the denitrification filters is shown in Figure 15.

For the wastewater to flow through the plant filters, an intermediate pumping station is needed, following the existing final clarifiers, to overcome the additional filter head loss. This station must be designed with multiple pumps to handle the full range of projected flow rates. Since denitrification is required year-round based on permit requirements, the pump station and filters would operate continuously.

Figure 15
 Site Plan - Denitrification Filters

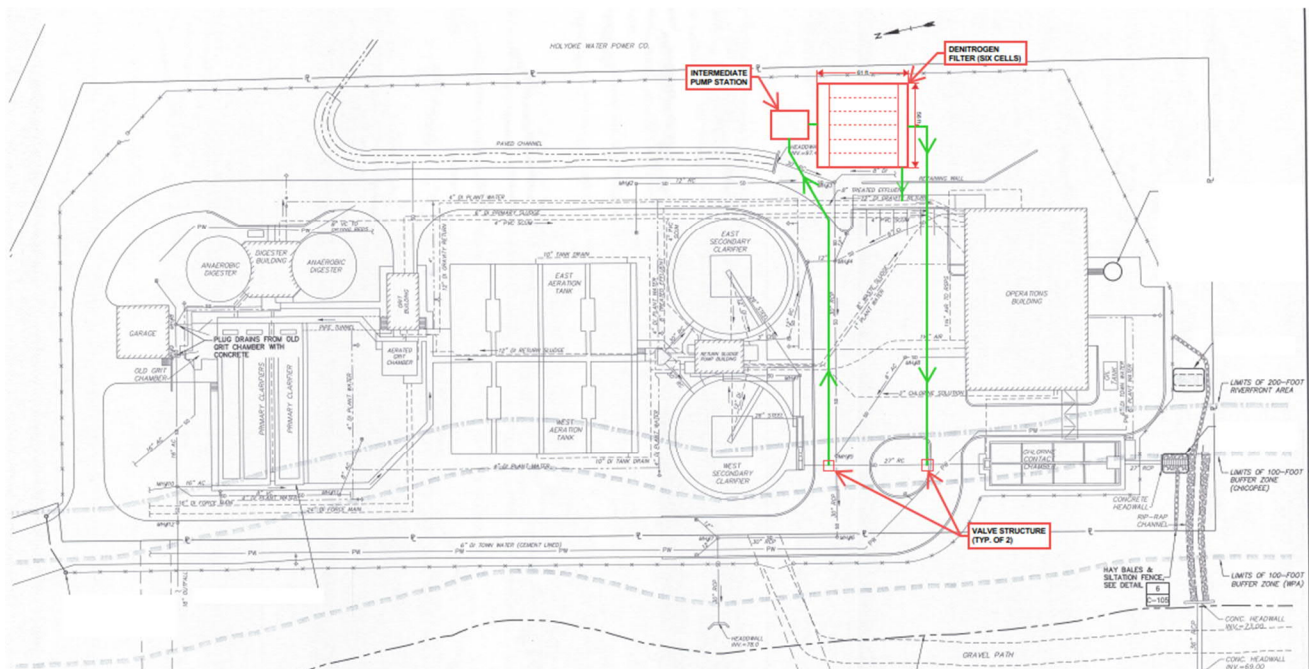

Advantages of denitrification filters include:

- The total nitrogen limit of 10 mg/l is readily achievable. Should the nitrogen limit be lowered in the future, the filters would provide that treatment capability;
- Existing treatment processes can be reused without major upgrades;
- Simplifies construction sequencing as most of the existing treatment process can remain active during the construction of new facilities.

There are several disadvantages of denitrification filters following nitrification. These include:

- High annual operating cost associated with supplemental carbon addition;

- High capital costs associated with the construction of filters and an intermediate pumping station;
- No operational savings from the recovery of alkalinity and dissolved oxygen.

An opinion of probable cost to construct downflow denitrification filters and associated appurtenances to treat the future design conditions is presented in Table 6-4.

Table 6-4
 Opinion of Probable Project Cost – Denitrification Filters

Capital Improvement	Cost (\$)
Filter Equipment	5,400,000
Intermediate Pump Station	1,500,000
Filter Building	1,500,000
Chemical Feed System	200,000
Miscellaneous Process Piping	400,000
Subtotal	9,000,000
Engineering and Contingency (45%)	4,050,000
Total Project Cost	13,050,000
Additional Annual Operations and Maintenance Cost	110,000

6.3 ALTERNATIVES TO IMPROVE DISINFECTION

As discussed in Chapter 4, South Hadley’s discharge permit imposes an average monthly limitation on E. coli of 126 colonies/100 mL from April 1 through October 31. Additionally, the permit limits the amount of residual chlorine that can be discharged to 1 mg/l. Disinfection is accomplished through the addition of sodium hypochlorite to the wastewater before it enters the chlorine contact tanks (CCTs). From review of the South Hadley WWTP effluent data from 2021 through 2024, the discharge consistently achieved a monthly average chlorine residual that is within the Permit guidelines. However, the monthly average E. coli concentration has exceeded the permit limitations on multiple occasions over the same period. This data suggests that the chlorine dosage was, on average, too low to disinfect the effluent wastewater to meet the permit requirement.

It has been reported that prior to the aeration system upgrades that were implemented in 2009, adequate disinfection was achieved with resulting residual chlorine concentrations below 1 mg/l. The aeration system upgrades did not have the desired positive impacts on the biological process as lower than expected oxygen levels and higher solids concentrations in the effluent may adversely impact disinfection. Alternatives to improve disinfection are discussed below.

6.3.1 CHLORINATION/DECHLORINATION

With the proper dose, sodium hypochlorite is a highly effective disinfectant. However, after disinfection a chlorine residual may reside in the effluent and if the concentration is too high, it can have negative impacts on the environment due to the toxicity of chlorine.

Matching the dose of sodium hypochlorite to the demand exerted by the wastewater is extremely difficult, particularly without any instrumentation. In typical practice, the dose is set high enough to ensure that adequate disinfection is achieved and then the excess is removed (dechlorination) prior to discharge. Implementing dechlorination into the disinfection system will allow for a higher chlorine dosage to target E. coli without risking permit excursions for residual chlorine.

Several chemicals can be used for dechlorination. These include sulfur dioxide, sodium metabisulfite, sodium bisulfite. Of those listed, sodium bisulfite is the simplest to use since it is commercially available in bulk in liquid form at a 40% solution. The chemical used for dechlorination needs to be mixed into the wastewater effluent, towards the downstream end of the CCTs. The dechlorination reaction will occur almost simultaneously.

To remove 2 mg/l of chlorine residual, the anticipated dose of sodium bisulfite is 1.6 gallons per hour (40 gallons per day) at the projected average daily flow of 3.3 mgd. The dechlorination system will consist of a 1,200-gallon chemical storage tank, metering pumps and the appropriate instrumentation for process control that continuously measures chlorine residual, or oxidation-reduction potential, before and after dechlorination. Although it may be possible to house the equipment in the operations building, for purposes of this planning effort, it has been assumed that a new pre-fabricated enclosure would be constructed in the parking lot to the south of the Operations Building. Since sodium bisulfite starts to crystallize at 50 degrees Fahrenheit, the enclosure will need provisions for temperature control for use during the months of April and October. Figure 16 depicts the proposed site layout for the dechlorination equipment. An opinion of probable project costs associated with the dechlorination system is presented in Table 6-5.

Figure 16
Dechlorination System Preliminary Layout

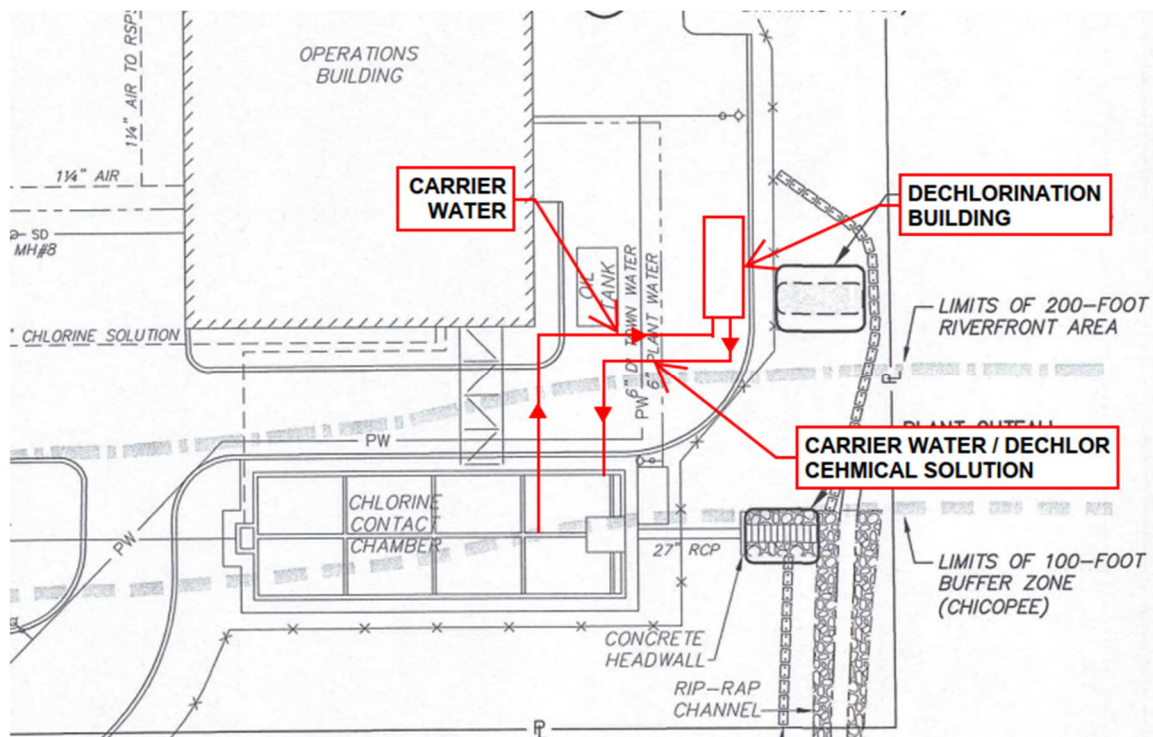

Table 6-5
 Opinion of Probable Project Cost – Chemical Dechlorination

Capital Improvement	Cost (\$)
Prefabricated Building with Storage Tank	200,000
Metering Pumps	40,000
Instrumentation / Electrical / HVAC	90,000
Subtotal	330,000
Engineering and Contingency (45%)	150,000
Total Project Cost	480,000
Additional Annual Operations and Maintenance Cost	20,000

6.3.2 ULTRAVIOLET DISINFECTION (PAIRED WITH UPSTREAM FILTRATION)

The use of UV light is an effective method for disinfecting municipal wastewater via germicidal radiation. It does not use chemicals, does not produce harmful chemical residuals and the equipment is generally simple to operate and maintain. In comparison to chlorination/dechlorination, the UV system will have a higher initial capital cost, but lower operating costs over time due to reduced chemical usage. The chemical savings will be offset by higher power consumption and annual lamp replacement costs, which are estimated at \$30,000/yr and \$20,000/yr, respectively. Annual lamp replacement cost In addition, UV disinfection is much more efficient with low suspended solids concentrations in the wastewater since solids can prevent the light from reaching the pathogens. Current effluent suspended solids concentrations at the South Hadley WWTP should support an effective UV system, however, if denitrification filters were implemented to reduce the effluent nitrogen concentration, UV would be a more attractive alternative. Due to the higher initial capital cost, the use of UV at the South Hadley WWTP, should not be considered at this time. An opinion of probable project cost to implement UV disinfection is presented in Table 6-5.

Table 6-6
 Opinion of Probable Project Cost – Ultraviolet Disinfection

Capital Improvement	Cost (\$)
Tank Modifications	400,000
UV Equipment	2,450,000
Electrical and Instrumentation	80,000
Subtotal	2,930,000
Engineering and Contingency (45%)	1,340,000
Total Project Cost	4,270,000
Additional Annual Operations and Maintenance Cost	30,000

6.4 REGIONAL APPROACH – INTERCONNECTION WITH THE CITY OF HOLYOKE

An alternative to upgrading the South Hadley WWTP is a regional approach whereby wastewater would be conveyed across the Connecticut River to the Holyoke WPCF. The evaluation presented herein is considered preliminary. A much more in-depth study will be needed to completely evaluate the validity of this alternative. That study will include an evaluation of Holyoke sewers impacted by the tie-in, discussions between representatives from both communities to determine logistical and financial obligations, discussions with South Hadley's regional partners in the wastewater system and discussions with the USEPA and MassDEP to identify their concerns with this alternative. While this approach avoids most of the capital costs associated with rehabilitating the South Hadley WWTP, it still involves a significant upfront capital investment.

Sewers in Holyoke were first constructed circa 1900 in the downtown area, along the Connecticut River. As development in the City progressed, the wastewater collection system expanded. Many sewers constructed before the late 1960s and/early 1970s were designed to convey both stormwater runoff and sanitary sewage. At that time, designing and building "combined" sewer systems was an acceptable and common practice. Several combined sewer overflows (CSOs) are located at various points in the collection system.

The City of Holyoke's wastewater collection system consists of approximately 140 miles of sewer, of which approximately 60 percent are combined. These sewers range from brick, concrete, and vitrified clay (VC) pipes in the older portions of the sewer system to reinforced concrete (RC), asbestos cement (AC), and polyvinyl chloride (PVC) pipes in the newer sections of the sewer system. The system includes several major interceptor sewers that receive flow from area collector sewers and convey that wastewater toward the City's WPCF.

The City of Holyoke has an agreement with Veolia North America ("Veolia") to operate, maintain, repair, and improve its wastewater and flood control system. Veolia is responsible for the WPCF, collection, stormwater, CSO, and flood control systems, and the industrial pretreatment program.

The Holyoke WPCF is a conventional activated sludge plant that utilizes high-purity oxygen. Designed to treat an average flow of 17.5 MGD, it currently treats approximately 8.0 mgd. It is designed to handle a peak flow of 37 mgd. Based on a preliminary evaluation, it would appear that Holyoke WPCF has available capacity to accommodate the average design flow (4.2 mgd) rate from South Hadley. However, Holyoke is in the process of implementing a Long-Term Control Plan to manage its CSOs and reduce overflows to the Connecticut River. Implementation of the program began in 2000, and it has been successful in reducing the annual combined sewer overflow volume by 66 percent. Twelve active CSO outfalls remain in the City that are controlled by 17 regulators. Completion of the recommended projects in the LTCP is not expected until the year 2039.

As a result, Holyoke's system is not expected to have sufficient capacity to accept South Hadley's design peak flow wet weather of 10.74 MGD. Wet weather storage will be required to temporarily hold excess wastewater that is generated during wet weather events. Once flows subside and downstream conditions allow, the stored wastewater would then be discharged to Holyoke.

Initial conversations with Veolia's former Superintendent for the Holyoke WWTF, Mike Williams, identified the following two potential connection points for discharging South Hadley's flow into Holyoke's collection system:

1. Upstream of the Mosher Street Pump Station
2. North Interceptor (downstream of the Mosher Pump Station)

For the first option, a capacity analysis of the Mosher Street Pump Station must be completed to determine whether upgrades are required to handle the additional flow from South Hadley. Assuming Holyoke's system can accept South Hadley's average daily flow of 4.2 MGD from the Main Street Pump Station, the Mosher Street Pump Station will require upgrading. Review of Holyoke's Operation and Maintenance Manual indicates that the station currently has a peak capacity of only 2,350 GPM (3.4 MGD) with two of the three pumps in operation.

Both connection options will also require a downstream capacity analysis of the North Interceptor. Regardless of which point is selected, all flow from South Hadley will ultimately discharge to Holyoke's WWTF via the North Interceptor on Canal Street. According to discussions with Mr. Williams, many subareas contributing to the 36-inch RCP North Interceptor have been separated, increasing available capacity. A hydraulic analysis of the interceptor is necessary to confirm remaining capacity and determine allowable flows from South Hadley.

Implementing this alternative would require two major infrastructure components in South Hadley:

1. A new sewer laid beneath the Connecticut River connecting South Hadley to Holyoke. Two lines would be constructed for redundancy.
2. Wet Weather storage for peak flows from South Hadley

Each component is discussed below.

Connecticut River Crossing:

A sewer pipe must be installed beneath the Connecticut River to convey South Hadley's wastewater to Holyoke. The crossing could include sewer force mains, siphons, or a combination of both. Trenchless construction methods—such as microtunneling or jack-and-bore—may be required depending on subsurface conditions and cost considerations.

A similar project was completed in 2022 for the Springfield Regional Wastewater Treatment Facility (SRWTF), approximately eight miles to the south of the South Hadley WWTP. That project included installation of a new pumping station, two 42-inch combined sewer force mains, and one 72-inch combined sewer siphon across the Connecticut River using microtunneling. Although pipe sizes are expected to be smaller, a comparable configuration is anticipated for South Hadley's connection to Holyoke.

A preliminary concept includes using the Main Street Pump Station to discharge average daily flows (dry-weather conditions) through a siphon installed beneath the river. The pump station would discharge to a new diversion structure located at the head-end of the existing South Hadley WWTP site. From this structure, flow would be conveyed to the siphon and then into Holyoke's system either upstream or downstream of the Mosher Street Pump Station. For redundancy, installation of a second siphon of equal size is recommended. A schematic of the conveyance system is shown in Figure 17.

Wet Weather Storage:

When wastewater flow, typically during wet weather conditions, exceeds the rate allowed by Holyoke, wet weather storage tanks would be used to temporarily hold excess flow. Valving within the diversion structure would direct flow to the storage tanks during such events. Once system conditions permit, stored wastewater would be pumped back to the diversion structure and discharged through the siphon to Holyoke. A cost-effective approach is to repurpose existing structures at the South Hadley WWTP such

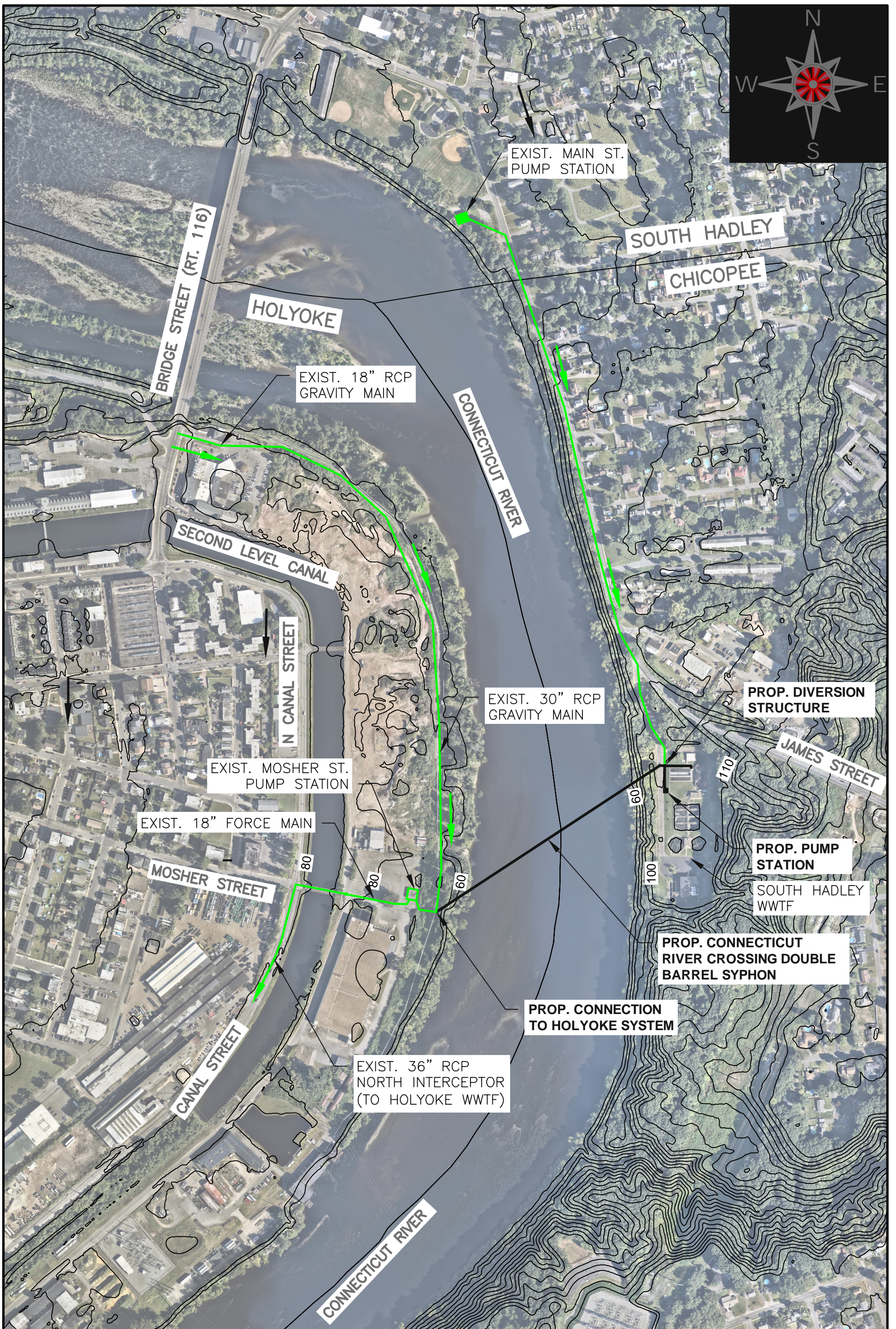

**South Hadley WWTF
Interconnection with Holyoke**

Figure No. 17

Scale: NONE

as the Primary Clarifiers and/or Aeration Basin Tanks – as wet weather storage tanks. These tanks would require mechanical mixing or aeration to maintain solids in suspension and prevent septic conditions. A dedicated pump station downstream of the storage tanks would be needed to convey stored flow back to the diversion structure and across the River via the new siphon. The concern regarding wet weather flow is the peak rate that will be allowed by Holyoke. Significant rain events could result in prolonged periods where daily flows could exceed the allowed discharge. Existing tanks used for storage could be inundated under these conditions, resulting in overflows.

As mentioned previously, this is a preliminary assessment of a regional solution with the City of Holyoke. It is unlikely that the City of Holyoke would be able to accept any wastewater from South Hadley until the completion of their LTCP in 2039. There are several issues that need to be resolved before an opinion of cost can be developed for this alternative.

7.0 RECOMMENDED PLAN

In Chapter 3 of this report the condition of the Town's existing pumping stations were evaluated and suggested improvements were identified. Similar evaluations were conducted for the wastewater treatment plant, and these were presented in Chapter 4. In Chapter 6, alternatives were evaluated to achieve compliance with the total nitrogen and the chlorine residual/E. coli limits in the Town's NPDES permit. This chapter summarizes the recommended improvements and provides opinions of probable costs to implement them.

7.1 RECOMMENDED PUMPING STATION IMPROVEMENTS

Main Street

A comprehensive evaluation of the Main Street pump station was completed by Wright-Pierce in February 2023. As discussed in detail in Chapter 3, a major upgrade of the station was recommended. Significant upgrades include:

- replacement of the pumps, valves and piping;
- replacement of exterior doors;
- construction of a water barrier 0.6 feet above the finished floor elevation for flood protection;
- replacement of handrails, hatches and grating;
- repair concrete on the wet side of the station;
- replace all ventilation in the station;
- replace all electrical conduits and switches in the wet well;
- replace main control panel;
- add fiber optic connection for future communication at the pump station;
- replace venturi tube with magnetic-type flow meter;
- replace all electrical distribution equipment (MCCs) and pump VFDs; and
- replace all station lighting with light-emitting diode (LED) lighting.

The opinion of project cost presented in the evaluation was \$9,490,000.

Stony Brook

The Stony Brook pump station was last upgraded in 2008, when it was converted from a pneumatic ejector to a submersible pump station. Although the station is presently in good condition mechanically, toward the latter half of the planning period, pumps, valves, HVAC equipment and the generator will need to be replaced. The concerns that should be addressed sooner are:

- replacement of the roof, which is damaged.
- replacement of the hot water heater, which has passed its useful life expectancy of 10 years.

The cost to replace the roof and water heater is estimated at \$20,000.

Morgan Street

The Morgan Street pump station is a small, duplex suction lift station that was constructed in 1991 to replace an older ejector type station that was constructed in the mid-1960s. Recommended improvements for the Morgan Street Pump Station include:

- converting the station to a submersible style station;

- Improving site access for pump trucks and other large equipment;
- Replacement of the emergency generators; and
- Replacement of HVAC equipment, which has a remaining life expectancy of 5 years.

The opinion of project cost to upgrade the Morgan Street pump station is \$620,000.

Old Sycamore

The Old Sycamore ejector station is the oldest pump station in Town as it was constructed in the 1960's. Some minor upgrades were completed in the 1990s. Besides the overall age of the station and the mechanical and electrical equipment within, other issues include the lack of a ladder assist on the access ladder and the suction line is known to be leaking where the pipe penetrates the station wall. Installed equipment is also non-explosion proof, which is a violation of the electrical code. Old Sycamore does not have a standby generator since flow can be directed to an overflow pipe that discharges to the Topors pump station if the station fails. It is recommended that this station be abandoned and that all flow be directed to the Topors station on a permanent basis. This will require removal of the existing equipment, filling in the chamber, site restoration and some piping modifications. The estimated cost to abandon the Old Sycamore station is \$25,000.

Topors

The Topors pump station is a small pneumatic ejector station constructed in 1973. With the recommended abandonment of the Old Sycamore station, recommended improvements include:

- Upgrading the station from an ejector station to a submersible station with adequate pumping capacity to handle flow from the Old Sycamore station. Due to limited space, this is expected to require bypass pumping from the existing manhole ahead of the station back to the existing forcemain. This will allow the existing station to be removed, and a new station installed.
- Installation of a new emergency generator and transfer switch;
- Upgrade the gravity sewer connecting the Old Sycamore pump station to the Topors pump station;
- Consideration should be given to lowering the operating range of the station to offer added protection to homes (#13 and #14 Sycamore Park) that are prone to back-ups.

The opinion of project cost to upgrade the Topors pump station is \$1,000,000.

7.2 RECOMMENDED WASTEWATER TREATMENT PLANT IMPROVEMENTS

7.2.1 RECOMMENDED IMPROVEMENTS FOR PERMIT COMPLIANCE

In Chapter 6, alternatives to remove nitrogen from the wastewater were evaluated. The recommended alternative is to convert the biological treatment process from a conventional activated sludge process to the Modified Ludzack Ettinger (MLE) process. Although, the total project cost to implement the MLE process was shown to be higher than that for Cyclical Nitrogen Removal, the MLE process is considered more reliable and gives the operator more operational control. Cyclical Nitrogen Removal was also shown to be less efficient in removing nitrogen, particularly when influent BOD loads are low, which is common in South Hadley. Process improvements will include:

- Conversion of the first basin in each biological treatment train to a dedicated anoxic zone and a swing zone of equal volume. This requires the construction of one wall to divide the basin in half and a second wall to split the dedicated anoxic zone into two passes.

- Installation of submersible mixers in each pass of the anoxic zone and in the swing zone;
- Installation of a fine bubble diffusers in the swing zone and the dedicated aerobic basin;
- Construction of a new enclosure to house blowers and associated electrical controls,
- Installation of three 75 HP positive displacement blowers capable of supplying 1,750 SCFM of air at 6.8 psi;
- Installation of two internal recycle pumps at the end of each aerobic basin. Each pump shall be capable of conveying 1.7 mgd of nitrified effluent back to the first pass in the anoxic zone.
- Installation of instrumentation in the biological reactors to monitor dissolved oxygen and pH. These instruments will serve to control the amount of air fed to the process for treatment and control the amount of chemical added to the process to maintain appropriate concentrations of alkalinity.
- Construction of a chemical storage tank (sodium hydroxide, magnesium hydroxide, sodium carbonate, etc.) and metering pumps.

Process evaluations in Chapter 6 also demonstrated that the installation of measures to chemically dechlorinate the final effluent would be the best means of achieving permit compliance with both the effluent limits for E. coli and Total Chlorine Residual. The total project cost and the annual operating costs for a chemical dechlorination process were shown to be much less than that of ultraviolet disinfection. Implementing means to reduce the concentration of residual chlorine in the discharge will allow sodium hypochlorite to be dosed at higher concentrations into the chlorine contact tanks to achieve more effective treatment of pathogens. Process improvements will include:

- Construction of a prefabricated, heated building to house either a 1,200-gallon bulk storage tank or a 275-gallon totes of sodium bisulfite. The building could be sited in a section of the existing parking lot in proximity to the effluent side of the chlorine contact tanks.
- Installation of pumps to meter bisulfite into the discharge end of the chlorine contact tanks;
- Instrumentation to monitor chlorine residual and/or ORP that will serve to adjust the dose of bisulfite.

7.2.2 GENERAL PROCESS AREA PLANT UPGRADES

Plant upgrades presented in this section are intended to address equipment that is operating beyond its typical design life or operating in an inefficient manner. These improvements, which are discussed by process area, are necessary to ensure the long-term reliability of the treatment process.

Grit Removal Facilities

The grit chamber has been in operation for over 40 years, and several pieces of equipment are original to the facility. The following improvements are recommended.

- Replace the bucket elevator, grit screw conveyor, and the dewatering screw; and
- Replace heavy duty, cast-iron plumbing drainage pipes.

Primary Treatment

- Replace the chain and flight sludge collectors in each of the three clarifiers, which were last replaced 1998. The Town has initiated this process.
- Separate the drives for clarifiers #2 and #3. One drive motor presently drives the sludge collectors both clarifiers. Separating the drives will improve redundancy.
- Replace the primary sludge plunger pumps located in the basement of the grit building with centrifugal style pumps;

- Replace the plunger pumps for primary scum that are located in the basement of the digester building with horizontal chopper-type pumps.

Biological Treatment

Recommendations presented in this section are in addition to the recommended change to the MLE treatment process for nitrogen removal discussed in Section 7.2.1. The existing secondary clarifiers were constructed in 1976 and with the exception of the drive motors that were replaced in 2009, most of the equipment is original.

- Replace the clarifier drives, rake arms, and sludge draw-off equipment.
- Replace the return activated sludge/waste activated sludge pumps with vertical centrifugal pumps.
- Replace the plunger style secondary scum pump with horizontal chopper type pumps. A second pump should be added for redundancy.

Solids Handling

Solids handling processes consist of sludge thickening and dewatering. Sludge thickening is performed in two steel-wall gravity thickeners that were installed in 1976 in a section of the operations building. Dewatering is accomplished via one belt filter press. Scum is also collected within various process tanks and is mixed and pumped along with settled sludge for processing. Dewatered sludge and scum are ultimately transported to a private incinerator for disposal. Recommended process related improvements include:

- For purposes of this report, replacement of the gravity thickeners in their entirety is recommended. Due to their age and the harsh environment in which they reside, the tanks are exhibiting signs of corrosion. The new gravity thickeners should be covered to reduce the volume of air that needs to be extracted for odor control purposes.
- Replacement of the two plunger type thickened sludge pumps with progressive cavity or other suitable style pumps.
- Replacement of single belt filter press with either two screw presses or two centrifuges. Two units are suggested for process redundancy. Presently, "redundancy" is achieved through the disposal of liquid sludge drawn directly from the gravity thickeners, which increases disposal costs. Both suggested means of dewatering carry similar cost so selection shall be based on operator preference. The screw presses do have a larger footprint than the centrifuges so installing them while maintaining operation of the belt press poses a greater challenge.
- Installation of new conveyors.
- Although a concern related to HVAC, the air handling and odor control system for the solids handling area and the operations building needs to be completely replaced. Twelve air changes per hour shall be provided in the thickener room and the belt filter press room. The exhaust will be treated for odors. For purposes of this evaluation a chemical scrubber has been incorporated into the project cost.

7.3 ANCILLARY SYSTEMS

7.3.1 ELECTRICAL SYSTEMS

Most of the equipment at the WWTP, and the electrical components that service the equipment, are out of date and past their design life. Most electrical equipment will require replacement as part of future WWTP upgrades. Recommended improvements include:

- Replace primary power feeds to all buildings.
- Replacing MCC-4 in the Grit Building.
- Replacing MCC-2 and Panel Boards A and B in the dewatering room.
- Replace all general use receptacles throughout the facility.
- Replace two 30 KVA transformers that provide power to Panelboard C.
- Replace MCC 3 and Panelboard C in the RAS Building.
- Replace all VFDs when pumps are replaced.
- When the primary scum pumps are replaced, motor starters shall be either rated for a NFPA Class 1 Div. 2 hazard environment or relocated from the lower level of the digester building to a non-hazardous location.
- Install fire alarms and exit signs in the digester building.

7.3.2 HVAC SYSTEMS

- Replace hot water unit heaters in the grit building.
- Replace the roof mounted exhaust fan and a corresponding roof mounted Intake Hood and connecting ductwork in the grit building.
- Provide a minimum of 3 air changes per hour in the lower-level pump room in the grit building.
- Insulate all hot water piping in the utility tunnel.
- Replace the hot water boiler in the digester building.
- Replace the electric unit heaters in the RAS Building.
- Replace the inoperative exhaust fans in the RAS building. Fans shall provide 12 air changes per hour.
- Replace the gas-fired hot water boiler in the operations building.
- Replace the rooftop air conditioning unit that serves the administrative space in the operations building.
- Replace the laboratory exhaust hood.

7.3.3 INSTRUMENTATION AND CONTROLS

The SCADA control system is configured with two separate PLC platforms. The system does not have redundant PLC processors should the main PLC processor fail. The remote input/output modules are approaching their useful life and are no longer supported by the manufacturer. It is therefore recommended that the SCADA system for the treatment plant be replaced.

7.3.4 PLUMBING SYSTEMS

Generally, plumbing fixtures, threaded gas pipe, copper pipe, fittings, and valves have an average lifespan of approximately 30 years. Fixtures and piping systems at the WWTP appear to be in fair condition and are nearing the end of their life expectancies. It must be noted that while the pipe exterior appears intact and continuous, the condition of the pipe interior including cleanliness, buildup of contaminants, pitting, corrosion, and thinning of the pipe walls is unknown. Based on observation at the WWTP, the following improvements are recommended.

- Replace cast iron drain piping and sump pumps throughout the facility.
- Repaint the non-potable and potable water distribution systems in the operations building to meet color requirements of the plumbing code.
- Replace copper distribution piping in the operations building.

7.3.5 ARCHITECTURAL IMPROVEMENTS

The buildings at the WWTP were constructed in the mid-1970s. Architectural components of the buildings such as windows, doors, and roofs are original to the facility and need to be replaced. Interior sections, particularly the administrative offices, also need to be refreshed with new flooring, ceilings and paint. Bathrooms and locker rooms in the operations building should also be updated.

Although interior space planning was not part of this planning effort, there is an opportunity to reconfigure some of the interior space. The number of in-house laboratory tests currently performed are much less than when the facility was first constructed. A smaller laboratory area with new cabinetry should be constructed, which would potentially improve workflow and storage capacity. Offices for plant operators should be established separate of the laboratory space.

The dewatering room is located in close proximity to the administrative offices. If centrifuges are installed to dewater solids, additional soundproofing should be installed on the adjoining walls.

7.4 OPINION OF PROBABLE PROJECT COST

Based on the scope of improvements discussed in this Chapter, an opinion of probable cost has been developed for the recommended WWTP upgrades. Costs presented in this section are in 2025 dollars referenced to an Engineering News Record Construction Cost Index of 18,576 (Boston, October 2025). Capital costs include construction costs for process equipment, structures, auxiliary equipment, piping, electrical, instrumentation, control systems, and allowances for contingencies, engineering, and project administration. Costs were determined through several methods including quotations from equipment suppliers, recent construction experience on similar projects, and published information on construction costs. Probable project costs are presented in Table 7-1.

7.5 FINANCIAL IMPACT ANALYSIS (TBD)

Funds to finance construction of wastewater infrastructure are commonly raised from four principal sources:

- Low-interest Loans from the Clean Water State Revolving Fund (CWSRF)
- General Obligation Bonds.
- Wastewater Enterprise Fund
- Inter-municipal Agreement (IMA) communities

The Clean Water State Revolving Fund (CWSRF) is a loan program established by the U.S. EPA that allows individual states to make low-interest loans to municipalities to cover the cost of wastewater improvement projects. Although engineering design costs are not eligible for funding under the CWSRF program in Massachusetts, loans are available to finance up to 100-percent of the project's construction cost including engineering services during construction. CWSRF loans typically have a payback period of 20 years and carry an interest rate of 2% (30-year financing is sometimes available at a higher interest rate). Funded projects usually include treatment facilities, interceptors, forcemains, pumping stations and sewer extensions. It is anticipated that most of the proposed work included in this CWMP will be eligible and funded through the CWSRF.

The Massachusetts CWSRF also offers other incentives. Recommended projects that have a nutrient removal component are eligible for loans at 0% interest (310 CMR 44.00). Since nitrogen removal is a key

Table 7-1
 Summary of Probable Project Cost - Wastewater Improvement Projects

Item	Construction Cost (\$)
Pumping Stations	
Main Street	7,030,000
Stony Brook	20,000
Morgan Street	900,000
Topors	1,000,000
Old Sycamore	20,000
Subtotal	8,970,000
Engineering Design (10%)	900,000
Engineering During Construction (10%)	900,000
Construction Contingency (25%)	2,240,000
Total Project Cost	13,010,000
Principle Forgiveness	(800,000)
Net Project Cost	12,210,000
Annualized Net Project Cost ¹	760,000
Wastewater Treatment Facility	
Grit Removal	1,150,000
Primary Treatment	1,570,000
Biological Treatment System (including MLE upgrade)	6,190,000
Disinfection Improvements	320,000
Solids Handling	5,600,000
Electrical Systems	5,110,000
HVAC Systems	2,620,000
SCADA System	550,000
Plumbing Systems	700,000
Architectural Improvements	1,200,000
Site Restoration	750,000
Subtotal	25,760,000
Engineering Design (10%)	2,580,000
Engineering During Construction (10%)	2,580,000
Construction Contingency (25%)	6,440,000
Total Project Cost	37,360,000
Principle Forgiveness	(2,300,000)
Net Project Cost	35,060,000
Annualized Net Project Cost ¹	1,810,000
Additional Annual O&M Cost	20,000
Total Annual Cost	2,590,000

1. Engineering design cost financed at 4% over 20 years
 Pump station construction costs financed through CWSRF at 2% over 20 years
 Treatment facility construction costs financed through CWSRF at 0% over 20 years.
 Principle forgiveness equal to 6.6 of project cost less engineering design

component of the recommended improvements to the WWTP, past practices indicate that all of the construction costs for the recommended WWTP upgrades will be eligible for 0% financing. Construction costs to upgrade the pumping stations and construct sewer extensions would be financed at a 2% interest rate.

In addition, South Hadley is designated by MassDEP as a Tier 2 Disadvantaged Community where the adjustable per capita income is between 60% and 80% of the state average. CWSRF funded projects in a Tier 2 Disadvantaged Community are eligible for 6.6% principal forgiveness.

General Obligation bonds are typically used by local governments to fund infrastructure projects. These bonds primarily rely on an issuing government's credit and taxation ability for its backing. For purposes of this financial analysis, it is assumed that engineering design costs for the recommended projects will be financed through a general obligation bond at an interest rate of 4%.

South Hadley has a Wastewater Enterprise Fund that is the dedicated financial account for the town's sewer system, funding essential operations and maintenance upgrades and small capital projects. The enterprise fund is supported from user fees. The current sewer use fee is \$500 per year per equivalent dwelling unit (EDU). This fee generates \$4,429,000 of income based on the 8,858 EDUs that are presently billed. An EDU is defined as 10,000 cubic feet of water consumption annually. However, in South Hadley all single-family homes are considered one EDU regardless of water consumption. Commercial establishments and industries are billed based on EDU calculations that are based on metered water consumption and/or strength of wastewater.

The intermunicipal agreements with the City of Chicopee and the Town of Granby allow for their participation if the costs to upgrade "Joint use Facilities". In the agreement with Chicopee, Joint Use Facilities are defined as the James Street sewer, the Main Street Pumping Station and the Wastewater Treatment Plant. In the agreement with Granby, the list of Joint Use Facilities is more extensive and includes the Morgan Street Pumping Station, the Morgan Street/Mosier Street interceptor, the Granby Road Interceptor, the Stony Brook Interceptor Sewer, the Connecticut River Interceptor Sewer, the Falls Interceptor Sewer, the Main Street Pumping Station and forcemain; and the Wastewater Treatment Plant. Chicopee's share in the cost to upgrade Joint Use Facilities is an allocated flow proportional share. The agreement with Granby states that costs to upgrade Joint Use Facilities will be included in the EDU sewer use charge system.

To assess financial impacts from the recommended projects, it has been assumed that the Town would apply for and receive funding for construction through the CWSRF program. Pump station construction would be funded at 2% interest over 20-year term while construction of the wastewater treatment facility would be funded at 0% (nitrogen removal project) over a 20-year term. Since the Town is designated as a Tier 2 Disadvantaged Community, principal forgiveness of 6.6% on the construction loans has been factored into financial impact analysis. As shown in Table 7-1, the estimated net total project cost (less principal forgiveness) to improve all of the Town's pump stations is \$12,210,000. The majority of the work is associated with the Main Street pump station, which conveys all flow to the treatment facility. The estimated total annual cost is \$760,000, or \$86 per EDU. The estimated net total project cost to improve the wastewater treatment facility is \$35,060,000. The estimated total annual cost is \$1,810,000 or \$206 per EDU.

Generally, obtaining CWSRF loans is a very competitive process. However, the nitrogen removal aspect of the treatment facility upgrade should serve to prioritize this project. MassDEP accepts applications in the summer, ranks projects in the fall and establishes a priority list over the winter for the next fiscal year. Since design of the noted improvements is expected to take 18 – 24 months, the CWSRF application should be submitted in 2027.

In addition to funding the recommendations discussed above, South Hadley must continue to invest money in its collection system. Aside from the five pumping stations, the collection system contains nearly 80 miles of sewer pipe. Several sections of the sewer system were constructed between 1920 and 1950. The condition of these sewers must be periodically evaluated so that long-term viability of the system is maintained. The current program that aggressively investigates sources of infiltration and inflow must also be continued to minimize impacts on the collection system and wastewater treatment facility. The success of the program is demonstrated by the recent upgrades made to the Judd Brook interceptor where infiltration and inflow rates have been significantly reduced.

7.6 IMPLEMENTATION SCHEDULE

7.6.1 *SEWER SYSTEM EXPANSION*

There is no defined schedule for expanding the sewer system into the defined needs areas. In fact, these areas were identified as potential areas to be sewerred in the 2001 CWMP and none have been constructed. Rather, these areas are identified as candidates for sewer expansion if the residents of those areas decide to request sewers. Since sewer expansion is largely paid for by betterment assessments on properties serviced by the new sewers, it is incumbent upon property owners in the areas to petition the Town for sewer expansion. Capacity is available at the WWTP to serve these areas.

7.6.2 *MAIN STREET PUMP STATION*

Since all flow to the wastewater treatment plant is conveyed through the Main Street Pump Station, it is the critical element in the collection system. The Town completed a detailed evaluation of the Main Street Pump Station in 2023. The noted improvements are intended to ensure that continued reliable service of this facility is maintained. Although the Town started implementing some of the recommended improvements (new generator, bypass connections, etc.), most of the noted improvements require engineering design so construction bids can be obtained. Design and construction of upgrades to this facility are a priority and should be initiated immediately upon approval of this plan.

7.6.3 *WASTEWATER TREATMENT PLANT UPGRADE*

South Hadley's wastewater treatment plant is an estimated \$100 million asset that treats wastewater from over 95% of the Town's residents and portions of the neighboring communities of Granby and Chicopee. The facility was constructed in 1976 and although several pieces of equipment have been replaced over the years, most of the systems date to the original construction. Again, significant upgrades are necessary to ensure that adequate and reliable treatment of the incoming wastewater is achieved prior to its discharge to the Connecticut River.

Phase I

Since the identified upgrades will require a significant capital investment, it is suggested that the upgrades be designed and constructed in two phases to ease the financial impact on system users. The first phase

would include improvements needed to achieve permit compliance and improve solids handling operations. Specifically, the first phase of design and construction would include:

- Conversion of the biological treatment process to the MLE process;
- Upgrades to the secondary clarifiers and the return sludge pumps;
- Disinfection improvements;
- Replacement of the gravity thickeners and related pumps and piping;
- Replacement of the belt filter press with new centrifuges;
- HVAC and odor control improvements in the solids processing area;
- Plant-wide electrical system upgrades;
- New SCADA system.

The estimated cost for Phase I improvements including engineering design fees is \$24,800,000. These improvements should be designed and constructed within the first five years following approval of this plan.

Phase II

The second phase of improvements will include:

- Upgrades to the aerated grit chamber and related equipment;
- Upgrades to the primary clarifiers and primary sludge pumps;
- HVAC improvements to the grit building;
- Architectural improvements in the Administration building;
- Replacement of roofs, windows and doors in other process buildings;
- General site improvements.

The estimated cost for Phase II improvements including engineering design fees is \$10,300,000. These improvements should be designed and constructed within 10 years following approval of this plan.

7.6.4 OTHER WASTEWATER PUMP STATIONS

Other than the Main Street Pump Station, no schedule has been established for the recommended upgrades to the other town-owned pump stations. Abandonment of the Old Sycamore pump station and the minor upgrades associated with the Stony Brook pump station can carry little capital cost and can take place at any time. However, abandonment of the Old Sycamore station should be tied to the recommended improvements Topors Station since wastewater that was handled by Old Sycamore will be directed to Topors. Due to the age of the Morgan Street station recommended improvements should be implemented within 10 years.

A timeline showing the schedule for completing wastewater infrastructure upgrades is shown in Figure 18.

Figure 18
Implementation Schedule
South Hadley Wastewater Infrastructure Upgrades

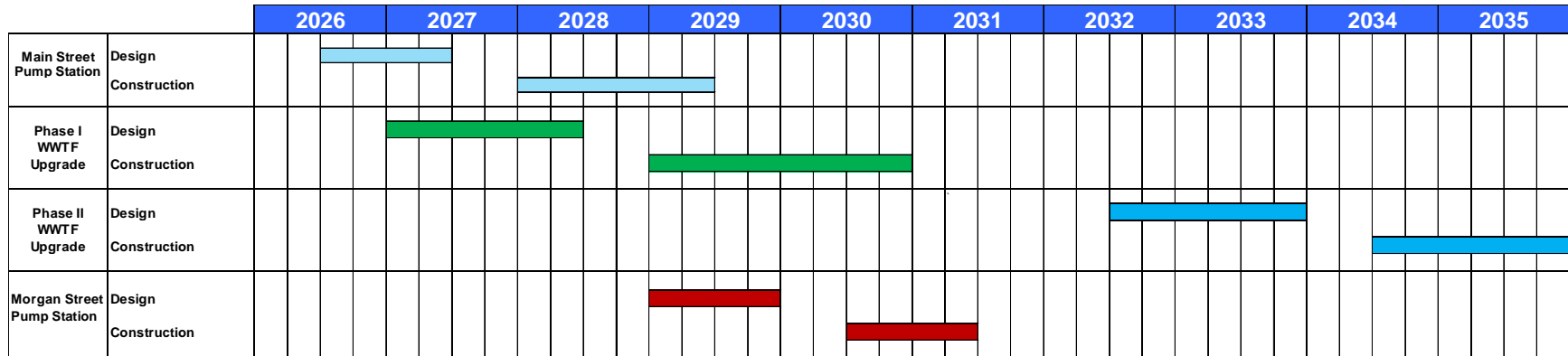

7.7 ENVIRONMENTAL ASSESSMENT

All of the recommended projects are expected to have minimal impact on the environment. This plan does not make any specific recommendations to extend sewers into areas of need. Instead, a few areas that do not have sewers have been identified. These areas are adjacent to the existing system but due to topographical influences, were not provided sewer service. Due to the small number of dwellings that would be serviced in each area, it is likely that the project costs and associated betterment assessments levied on the properties would be prohibitive. Many of these areas were identified in previous wastewater planning documents, but remain unsewered for these reasons.

If sewers were to be constructed, nearly all of the construction would occur within existing paved roadways. Minor easements may be necessary to connect certain areas. It is likely that most of the sewers would be constructed as shallow low-pressure systems with individual grinder pumps. Therefore, conventional construction methods will be utilized in most cases, such as trench excavation and backfill for pipe installations and open excavation for structures and pump stations.

Proposed construction at the treatment facility is limited to areas that are already disturbed. Most of the construction will take place within the footprint of existing buildings and process tanks. New construction is limited to a building to house blowers and an enclosure to house sodium bisulfite storage containers and related feed pumps. The expected environmental benefit associated with the consistent removal of nitrogen from the wastewater and more effective disinfection prior to its discharge to the Connecticut River, outweigh any temporary construction related environmental impacts.

The proposed projects do not meet any of the review thresholds of the Massachusetts Environmental Policy Act (MEPA). For projects to require the filing of an Environmental Notification Form (ENF) and the mandatory preparation of an Environmental Impact Report (EIR) they must meet one or more of the following criteria:

1. Construction of a New wastewater treatment and/or disposal facility with a capacity of 2.5 mgd or more.
2. New interbasin transfer of wastewater of 1.0 mgd or more or any amount determined significant by the Water Resource Commission.
3. Construction of one or more new sewer mains ten or more miles in length.
4. Provided that the project is undertaken by an Agency, new sewer service to a municipality or sewer district across a municipal boundary through new or existing pipelines.
5. New discharge or expansion in discharge of any amount of sewage, industrial waste water or untreated stormwater directly to an outstanding resource water.
6. New Capacity or Expansion in Capacity for storage, treatment, processing, combustion or disposal of 150 or more wet tons per day of sewage sludge, sludge ash, grit, screenings, or other sewage sludge residual materials, unless the project is an expansion of an existing facility within an area that has already been sited for the proposed use.

For projects to require the submittal of an ENF and other MEPA review, if the Secretary so requires, they must exceed one or more of the following thresholds:

1. Construction of a new wastewater treatment and/or disposal facility with a capacity of 100,000 or more gpd.
2. Expansion of an existing wastewater treatment and/or disposal facility by the greater of 100,000 gpd or 10% of existing capacity.
3. Construction of one or more new sewer mains:
 - a. that will result in an expansion in the flow to a wastewater treatment and/or disposal facility by 10% of existing capacity; or
 - b. five or more miles in length.
4. New discharge or expansion in discharge:
 - a. to a sewer system of 100,000 or more gpd of sewage, industrial wastewater or untreated stormwater;
 - b. to a surface water of:
 - i. 100,000 or more gpd of sewage;
 - ii. 20,000 or more gpd of industrial waste water; or
 - iii. any amount of sewage, industrial waste water or untreated stormwater requiring a variance from applicable water quality regulations; or
 - c. to groundwater of:
 - i. 10,000 or more gpd of sewage within an area, zone or district established, delineated or identified as necessary or appropriate to protect a public drinking water supply, an area established to protect a nitrogen sensitive embayment, an area within 200 feet of a tributary to a public surface drinking water supply, or an area within 400 feet of a public surface drinking water supply;
 - ii. 50,000 or more gpd of sewage within any other area;
 - iii. 20,000 or more gpd of industrial wastewater; or
 - iv. any amount of sewage, industrial wastewater or untreated stormwater requiring approval by the Department of Environmental Protection of a variance from Title 5 of the State Environmental Code for New construction.
5. New capacity or expansion in capacity for:
 - a. combustion or disposal of any amount of sewage sludge, sludge ash, grit, screenings, or other sewage sludge residual materials; or
 - b. storage, treatment, or processing of 50 or more wet tons per day of sewage sludge or sewage sludge residual materials.

7.7.1 MITIGATION

As with any construction project, short-term environmental impacts are expected. The following summarizes proposed mitigation measures that will be implemented by the Town and the contractor. The contractor will coordinate with the Town and other authorities such as MassDEP and MHD as necessary for implementation of the measures. It will be the responsibility of the Town to ensure that the contractor is carrying out the proposed mitigation measures. The construction projects will include the services of an engineering consultant and a resident engineer at the project sites, who will act on behalf of the Town to make sure that the contractor adheres to the project design criteria and specifications. The resident

engineer will monitor the mitigation measures implemented by the contractor and advise the Town if they are not adequate.

Air Quality

Impacts to air quality during construction will be mitigated to the maximum extent through various measures incorporated into the project design. To reduce dust during construction activities, open cuts, and exposed areas shall be backfilled and stabilized as soon as each segment of pipe is installed, and at the same time, non-backfill material shall be removed from the site and transported to an appropriate disposal location; any stockpiled material that must remain on-site for more than 24 hours shall be covered. Exposed surfaces will be wetted and stabilized to minimize dust generation. All trucks for transportation of construction material will be fully covered, and street sweeping will occur as needed.

All motor vehicles and construction equipment shall comply with all pertinent local, state, and federal regulations regarding exhaust emissions. Construction equipment not in use and trucks that are idling while waiting to load or unload material will be turned off.

Water Resources and Water Quality

Impacts to water bodies will be mitigated through the use of Best Management Practices for construction projects. Activities will also be coordinated with local NPDES Stormwater Management Plan and the Conservation Commission. The Conservation Commission in Chicopee has jurisdiction over wastewater WWTP work while the South Hadley Conservation Commission has jurisdiction over the pump stations. Erosion and sedimentation control measures shall be installed and functional before excavation operations begin and shall be properly maintained throughout the construction period. Staked and entrenched straw bales and/or silt fence shall be installed along wetland resource areas to prevent erosion into streams and wetlands. All control measures shall be checked weekly and after each rainfall.

Excavated material shall be placed on the upslope side of the trench to permit any erosion from the material to be captured by the trench. Grading activities shall be avoided during periods of high rainfall. Construction shall be staged in sections. Areas disturbed for each section shall be stabilized immediately upon completion of the section. Stabilization shall be accomplished by temporarily or permanently protecting the disturbed soil surface from rainfall impacts and run-off and/or repaving cuts in roadways or sidewalks.

Construction dewatering from open cuts and trenches shall be routed through appropriately designed sediment basins or traps and discharged through a pipe or lined channel to a stream or other surface water body (under an applicable construction dewatering permit), unless such dewatering can be handled in another manner not requiring discharge to a water body.

Maintenance, repair, and fueling of equipment shall be confined to areas specifically designed for that purpose. These areas will have adequate waste disposal receptacles for liquid and solid waste. Waste oil shall be removed to designated waste oil collection areas for recycling. No potential pollutants shall be allowed to drain into catch basins, streams, or other water bodies.

When using fertilizer to establish areas of new vegetation for soil stabilization, mulches shall be used to prevent fertilizer nutrients from washing off the vegetated areas. Fertilizer shall not be applied if there is likelihood of a significant rainstorm. Fertilizer shall not be applied unless there is adequate protection of surface water, groundwater, and pipeline systems.

Noise

Measures to minimize noise from construction activities will be incorporated into the construction plans. Where practical, construction will occur during daytime hours (7:00 AM to 3:00 PM), excluding weekends. Construction equipment will have appropriate mufflers to minimize noise and idle equipment will be shut off.

Transportation

Truck routing to the project areas will utilize connectors and major routes. No trucking will be allowed to approach the site using local roads and through neighborhoods unless necessary for access. Truck traffic will vary throughout the construction period, depending on the activity.

Where necessary, police details will be stationed at the project location to coordinate traffic flow and assist in pedestrian direction. Truck routing and traffic management plans will be reviewed and coordinated with the South Hadley DPW. For work in state roads, construction activities and traffic management will adhere to the permit issued by the MHD. Street sweeping will be performed as required and daily during all heavy trucking periods.

Disposal of Excess Material

The contractor will be directed to reuse suitable excavated material to the greatest extent feasible. Excess soil that cannot be reused on-site will be transported in covered trucks to an approved disposal site. If contaminated soils are encountered through subsurface exploration during the project design or during construction, they will be managed and disposed of at an approved facility according to MassDEP regulations.

Wetlands and Floodplains

Wetland resource areas and their associated buffer zones will be clearly marked as off-limits to construction equipment and materials storage. Excavated material will not be placed between the excavation and a wetland resource area. Excavations shall be promptly backfilled and stabilized to reduce the risk of erosion. Stockpiled soil shall be located away from streams and drainage ways so that runoff cannot carry sediment downstream.

Vegetated Areas

Clearing and grubbing shall be held to a minimum, as necessary for grading and equipment operation and construction shall be sequenced to minimize the exposure time of cleared surface areas. Soil will be stabilized with perennial vegetation as soon as possible after final grading. All cuts, fills, and disturbed areas adjacent to paved areas and roadways shall be stabilized with appropriate temporary or permanent vegetation.

Adjacent Land Use

The project will not impact adjacent land use such as protected open space, parks, or recreational areas.

Historic Resources

The proposed construction will occur within the confines of disturbed/developed properties. Pipeline construction will not proceed onto private properties. Therefore, no impact to historic properties is anticipated.

7.8 STATE AND LOCAL PERMITS

This section provides updates on the status of each state permit or agency action potentially required for the construction of treatment facility and pump station upgrades. Agency actions still required for the project consist of approval of the Final CWMP from MassDEP. Approval of the CWMP by MassDEP, will allow for project funding under the Massachusetts SRF program, if desired by the Town. State and local permits required for the project are outlined in the following summary and will be prepared during project design when an adequate level of detail is available.

1. Prepare and submit a Notice of Intent under the Wetlands Protection Act and the Rivers Protection Act and submit to the appropriate Conservation Commission during the project design for each phase of the plan. The Notice of Intent will be prepared for all construction proposed within resource areas and the Order of Conditions obtained will be adhered to.
2. WP16 – New/Modified Plan Approval for Surface Water Discharge (NPDES) Facilities, without Permit Modification. No permit modifications are needed to construct and implement the proposed improvements to the WWTP.
3. Prepare and submit an Access Permit to the Massachusetts Highway Department (MHD) during project design for construction occurring within state roadway layouts.
4. Building Codes – The proposed new and upgraded pump stations may consist of above-ground structures. For any proposed building structure, the project design will adhere to applicable state and local building codes.
5. Flood Plain Management – No work within the FEMA 100-year flood plain is anticipated. If it is determined during project design that proposed pump station structures are within the 100-year flood plain, the design will adhere to applicable flood plain management policies, including storage volume replication.
6. Stormwater Management – A NPDES Construction General Permit will only be required if the proposed projects will disturb greater than one-acre of land and discharge site stormwater to the Town's drainage system. This permit requires the preparation of a Stormwater Pollution Prevention Plan, which will be the obligation of the project contractor to prepare, and submittal of a Notice of Intent to EPA.
7. Dewatering – A NPDES General Permit for Construction Dewatering will likely not be required. If a construction dewatering permit is required, it will be coordinated with MassDEP and the appropriate Conservation Commission.
8. In the event that contaminated soil and/or groundwater is encountered and will be disturbed during construction of the proposed infrastructure, a Utility-Related Abatement Measure (URAM) will be prepared and filed with the MassDEP.

8.0 PUBLIC PARTICIPATION

8.1 PUBLIC MEETINGS

A Public Meeting to kick-off the CWMP process was held on September 24, 2024 as part of a regularly scheduled meeting of the Selectboard at the Senior Center. The meeting was included on the agenda for the meeting and was advertised accordingly. The meeting was also televised by the local cable network. At the time of this meeting, the “needs analysis” portion of the CWMP was approximately 50-percent complete. The purpose of the meeting was to inform the Selectboard of the CWMP process and present findings to date. A copy of the meeting agenda and the slides from the PowerPoint presentation given by BETA Group, Inc. are provided in Appendix C.

A second Public Meeting will be held on January 6, 2026 at a regularly scheduled meeting of the Selectboard. The Draft CWMP is complete and the recommended plan will be presented.

8.2 PUBLIC HEARING

Once MassDEP has reviewed and provided comment on the document, a Public Hearing will be held at a time and location to be determined.

Appendix A: South Hadley NPDES Permit

**AUTHORIZATION TO DISCHARGE UNDER THE
NATIONAL POLLUTANT DISCHARGE ELIMINATION SYSTEM MEDIUM
WASTEWATER TREATMENT FACILITY GENERAL PERMIT**

In compliance with the provisions of the Federal Clean Water Act, as amended, (33 U.S.C. §§ 1251 et seq.; the "CWA"),

**Town of South Hadley, Massachusetts
Board of Selectmen**

is authorized to discharge from the facility located at

**South Hadley Wastewater Treatment Plant
2 James Street
Chicopee, MA 01020**

to receiving water named

**Connecticut River
Connecticut River Watershed**

in accordance with effluent limitations, monitoring requirements and other conditions set forth in this authorization and the Medium WWTF GP (General Permit No. MAG590000).

The Town of Granby is also identified as a Co-permittee related to operation and maintenance of the sewer system in compliance with the Standard Conditions of Part VII and the terms and conditions of Part II.C, Unauthorized Discharges; Part III.A, Operation and Maintenance of the Sewer System (which include conditions regarding the operation and maintenance of the collection systems owned and operated by the municipality); and Part III.B, Alternate Power Source. The permit number assigned to the Town of Granby for purposes of reporting (using NetDMR through EPA's Central Data Exchange, as specified in Part V below) in accordance with the requirements in Parts II.C, Part III.A, and Part III.B of this permit is **MAG59C121**.

The Permittee and Co-permittee are severally liable for their own activities under Parts II.C, III.A and III.B and required reporting under Part V with respect to the portions of the collection system that they own or operate. They are not liable for violations of Parts II.C, III.A and III.B committed by others relative to the portions of the collection system owned and operated by others. Nor are they responsible for any reporting under Part V that is required of other Permittees under Parts II.C, III.A and III.B.

This authorization shall become effective on April 1, 2023.

For applicable attachments see the complete version of the Medium WWTF General Permit:

Part VII – Standard Conditions

Attachment A – Freshwater Acute Toxicity Test Procedure and Protocol, February 2011

Attachment B – Freshwater Chronic Toxicity Test Procedure and Protocol, March 2013

Attachment C – Marine Acute Toxicity Test Procedure and Protocol, July 2012

Attachment D – Marine Chronic Toxicity Test Procedure and Protocol, November 2013

Attachment E – List of Eligible Facilities

Attachment F – Reassessment of Technically Based Industrial Discharge Limits

Attachment G – NPDES Permit Requirement for Industrial Pretreatment Annual Report

Attachment H – PFAS Analyte List

Attachment I – Facility-Specific Permit Terms

Attachment J – Pretreatment Program Development Requirements

I. Applicability and Coverage of the WWTF GP

Supplementary information provided in the complete version of the Medium WWTF GP.

II. General Permit Requirements

A. Effluent Limitations and Monitoring Requirements

During the period beginning on the effective date and lasting through the expiration date, the Permittee is authorized to discharge treated effluent through Outfall Serial Number 001 to the Connecticut River. The discharge shall be limited and monitored as specified below at the end of all treatment processes, including disinfection or dechlorination, or at an alternative representative location approved by EPA and the Massachusetts Department of Environmental Protection (MassDEP), that provides a representative sample of the effluent. The receiving water and the influent shall be monitored as specified below.

Table 1. Effluent Limitations and Monitoring Requirements

Effluent Characteristic Parameter	Discharge Limitation			Monitoring Requirement ^{1,2}	
	Average Monthly	Average Weekly	Maximum Daily	Measurement Frequency	Sample Type ³
Rolling Average Effluent Flow ⁴	4.2 MGD	---	---	Continuous	Recorder
Effluent Flow ⁴	Report MGD	---	Report MGD	Continuous	Recorder
BOD ₅	30 mg/L 1051 lb/day	45 mg/L 1576 lb/day	Report mg/L	1/Week	Composite
BOD ₅ Removal	≥ 85 %	---	---	1/Month	Calculation
TSS	30 mg/L 1051 lb/day	45 mg/L 1576 lb/day	Report mg/L	1/Week	Composite
TSS Removal	≥ 85 %	---	---	1/Month	Calculation
pH Range ⁷	6.5 - 8.3 S.U.			5/Week	Grab
<i>Escherichia coli</i> ⁸ (April 1 - October 31)	126 colonies/ 100 mL	---	409 colonies/100 mL	1/Week	Grab
Total Residual Chlorine ⁹	1.0 mg/L	---	1.0 mg/L	5/Week	Grab
Total Kjeldahl Nitrogen ¹¹ (April 1 – October 31)	Report mg/L	---	Report mg/L	1/Week	Composite
(November 1 – March 31)	Report mg/L	---	Report mg/L	1/Month	Composite
Nitrate + Nitrite ¹¹ (April 1 – October 31)	Report mg/L	---	Report mg/L	1/Week	Composite
(November 1 – March 31)	Report mg/L	---	Report mg/L	1/Month	Composite

Effluent Characteristic Parameter	Discharge Limitation			Monitoring Requirement ^{1,2}	
	Average Monthly	Average Weekly	Maximum Daily	Measurement Frequency	Sample Type ³
Total Nitrogen ¹¹	Report mg/L Report lb/day	---	Report mg/L	1/Month	Calculation
Rolling Average Total Nitrogen ¹¹	350 lb/day	---	---	1/Month	Calculation
PFAS Analytes ¹²	---	---	Report ng/L	1/Quarter	Composite
Whole Effluent Toxicity (WET) Testing^{14,15}					
Acute (LC ₅₀) (Test Species: <i>Ceriodaphnia dubia</i>)	---	---	≥ 50%	2/Year	Composite
Hardness (as CaCO ₃)	---	---	Report mg/L	Same as WET Measurement Frequency and Sample Type	
Ammonia Nitrogen	---	---	Report mg/L		
Total Aluminum	---	---	Report mg/L		
Total Cadmium	---	---	Report mg/L		
Total Copper	---	---	Report mg/L		
Total Lead	---	---	Report mg/L		
Total Nickel	---	---	Report mg/L		
Total Zinc	---	---	Report mg/L		
Total Organic Carbon	---	---	Report mg/L		

Ambient Characteristic ¹⁶	Reporting Requirements		Monitoring Requirements ^{1,2,3}		
	Average Monthly	Average Weekly	Maximum Daily	Measurement Frequency	Sample Type ⁴
Hardness	---	---	Report mg/L	Same as WET Monitoring Frequency	Grab
Ammonia Nitrogen	---	---	Report mg/L		Grab
Total Aluminum	---	---	Report mg/L		Grab
Total Cadmium	---	---	Report mg/L		Grab
Total Copper	---	---	Report mg/L		Grab
Total Nickel	---	---	Report mg/L		Grab
Total Lead	---	---	Report mg/L		Grab
Total Zinc	---	---	Report mg/L		Grab
Total Organic Carbon	---	---	Report mg/L		Grab

Dissolved Organic Carbon ¹⁷	---	---	Report mg/L		Grab
pH ¹⁸	---	---	Report S.U.		Grab
Temperature ¹⁸	---	---	Report °C		Grab

Influent Characteristic	Reporting Requirements			Monitoring Requirements ^{1,2,3}	
	Average Monthly	Average Weekly	Maximum Daily	Measurement Frequency	Sample Type ⁴
BOD ₅	Report mg/L	---	---	2/Month	Composite
TSS	Report mg/L	---	---	2/Month	Composite
PFAS Analytes ¹²	---	---	Report ng/L	1/Quarter	Composite

Sludge Characteristic	Reporting Requirements			Monitoring Requirements ^{1,2,3}	
	Average Monthly	Average Weekly	Maximum Daily	Measurement Frequency	Sample Type ⁴
PFAS Analytes ²⁰	---	---	Report ng/g	1/Quarter	Composite ²¹

Footnotes to Part II.A. Table 1:

1. All samples shall be collected in a manner to yield representative data. A routine sampling program shall be developed in which samples are taken at the same location, same time and same days of the week each month. Occasional deviations from the routine sampling program are allowed, but the reason for the deviation shall be documented as an electronic attachment to the applicable discharge monitoring report. The Permittee shall report the results to the Environmental Protection Agency Region 1 (EPA) and MassDEP of any additional testing above that required herein, if testing is in accordance with 40 CFR Part 136.
2. In accordance with 40 CFR § 122.44(i)(1)(iv), the Permittee shall monitor according to sufficiently sensitive test procedures (i.e., methods) approved under 40 CFR Part 136 or required under 40 CFR chapter I, subchapter N or O, for the analysis of pollutants or pollutant parameters (except WET). A method is “sufficiently sensitive” when: 1) The method minimum level (ML) is at or below the level of the effluent limitation established in the permit for the measured pollutant or pollutant parameter; or 2) The method has the lowest ML of the analytical methods approved under 40 CFR Part 136 or required under 40 CFR chapter I, subchapter N or O for the measured pollutant or pollutant parameter. The term “minimum level” refers to either the sample concentration equivalent to the lowest calibration point in a method or a multiple of the method detection limit (MDL), whichever is higher. Minimum levels may be obtained in several ways: they may be published in a method; they may be based on the lowest acceptable calibration point used by a laboratory; or they may be calculated by multiplying the MDL in a method, or the MDL determined by a laboratory, by a factor.

When a parameter is not detected above the ML, the Permittee must report the data qualifier signifying less than the ML for that parameter (e.g., < 50 µg/L, if the ML for a parameter is 50 µg/L). For reporting an average based on a mix of values detected and not detected, assign a value of “0” to all non-detects for that reporting period and report the average of all the results.

3. A “grab” sample is an individual sample collected in a period of less than 15 minutes.

A “composite” sample is a composite of at least twenty-four (24) grab samples taken during one consecutive 24-hour period, either collected at equal intervals and combined proportional to flow or continuously collected proportional to flow.
4. The limit is a rolling annual average, reported in million gallons per day (MGD), which will be calculated as the arithmetic mean of the monthly average flow for the reporting month and the monthly average flows of the previous eleven months. Also report monthly average and maximum daily flow in MGD.
5. N/A
6. N/A

7. The pH shall be within the specified range at all times. The minimum and maximum pH sample measurement values for the month shall be reported in standard units (S.U.). Continuous monitoring also fulfills the 5/week monitoring frequency.
8. The monthly average limits for bacteria are expressed as a geometric mean.

Bacteria monitoring shall be conducted concurrently with TRC monitoring, if TRC monitoring is required.

For samples tested using the Most Probable Number (MPN) method, the units may be expressed as MPN. The units may be expressed as colony forming units (cfu) when using the Membrane Filtration method.

9. For total residual chlorine (TRC) limitations and other related requirements, see Part II.B.9 of this permit.
10. N/A

11. Total Kjeldahl nitrogen and nitrate + nitrite samples shall be collected concurrently. The results of these analyses shall be used to calculate both the concentration and mass loadings of total nitrogen, as follows.

Total Nitrogen (mg/L) = Total Kjeldahl Nitrogen (mg/L) + Nitrate + Nitrite (mg/L)

Total Nitrogen (lbs/day) = [(average monthly Total Nitrogen (mg/L) * total monthly effluent flow (Millions of Gallons (MG)) / # of days in the month] * 8.34

See additional requirements in Part III.G of this permit.

The rolling annual total nitrogen limit is an annual average mass-based limit (lb/day), which shall be reported as a rolling 12-month average. The value will be calculated as the arithmetic mean of the monthly average total nitrogen for the reporting month and the monthly average total nitrogen for the previous 11 months. Report both the rolling annual average and the monthly average each month.

See Part III.F below for a compliance schedule applicable to the total nitrogen limit.

12. Report in nanograms per liter (ng/L). This reporting requirement for the listed PFAS parameters takes effect the first full calendar quarter after the effective date of the authorization to discharge under the General Permit. Until there is an analytical method approved in 40 CFR Part 136 for PFAS in wastewater, monitoring shall be conducted using Draft Method 1633.

Additionally, report in NetDMR the results of all other PFAS analytes required to be tested as part of the method as shown in Attachment H. Any parameters that are removed from the method based on multi-lab validation of the method will not be required for reporting and the Permittee may report "NODI: 9" for any such parameters.

13. N/A

14. The Permittee shall conduct acute toxicity tests (LC50) in accordance with test procedures and protocols specified in **Attachment A** of this permit. LC50 is defined in Part VII.E. of this permit. The Permittee shall test the daphnid (*Ceriodaphnia dubia*). Toxicity test samples shall be collected during the same weeks each time of calendar quarters ending June 30th and September 30th. The complete report for each toxicity test shall be submitted as an attachment to the DMR submittal which includes the results for that toxicity test.
15. For Part I.A.1., Whole Effluent Toxicity Testing, the Permittee shall conduct the analyses specified in **Attachment A**, Part VI. CHEMICAL ANALYSIS for the effluent sample. If toxicity test(s) using the receiving water as diluent show the receiving water to be toxic or unreliable, the Permittee shall follow procedures outlined in **Attachment A**, Section IV., DILUTION WATER. Minimum levels and test methods are specified in **Attachment A**, Part VI. CHEMICAL ANALYSIS.
16. For Part I.A.1., Ambient Characteristic, the Permittee shall conduct the analyses specified in **Attachment A**, Part VI. CHEMICAL ANALYSIS for the receiving water sample collected as part of the WET testing requirements. Such samples shall be taken from the receiving water at a point immediately upstream of the permitted discharge's zone of influence at a reasonably accessible location, as specified in **Attachment A**. Minimum levels and test methods are specified in **Attachment A**, Part VI. CHEMICAL ANALYSIS.
17. Monitoring and reporting for dissolved organic carbon (DOC) are not requirements of the Whole Effluent Toxicity (WET) tests but are additional requirements. The Permittee may analyze the WET samples for DOC or may collect separate samples for DOC concurrently with WET sampling.
18. A pH and temperature measurement shall be taken of each receiving water sample at the time of collection and the results reported on the appropriate DMR. These pH and temperature measurements are independent from any pH and temperature measurements required by the WET testing protocols.
19. N/A
20. Report in nanograms per gram (ng/g). This reporting requirement for the listed PFAS parameters takes effect the first full calendar quarter after the effective date of the authorization to discharge under the General Permit. Until there is an analytical method approved in 40 CFR Part 136 for PFAS in sludge, monitoring shall be conducted using Draft Method 1633.

Additionally, report in NetDMR the results of all other PFAS analytes required to be tested as part of the method, as shown in Attachment H. Any parameters that are removed from the method based on multi-lab validation of the method will not be required for reporting and the Permittee may report "NODI: 9" for any such parameters.
21. Sludge sampling shall be as representative as possible based on guidance found at <https://www.epa.gov/sites/production/files/2018-11/documents/potw-sludge-sampling-guidance-document.pdf>.

B. Other Requirements

1. The discharge shall not cause a violation of the water quality standards of the receiving water.
2. The discharge shall be free from pollutants in concentrations or combinations that, in the receiving water, settle to form objectionable deposits; float as debris, scum or other matter to form nuisances; produce objectionable odor, color, taste or turbidity; or produce undesirable or nuisance species of aquatic life.
3. The discharge shall be free from pollutants in concentrations or combinations that adversely affect the physical or chemical nature of the bottom, interfere with the propagation of fish or shellfish, or adversely affect populations of non-mobile or sessile benthic organisms.
4. The discharge shall not result in pollutants in concentrations or combinations in the receiving water that are toxic to humans, aquatic life or wildlife.
5. The discharge shall be free from floating, suspended and settleable solids in concentrations or combinations that would impair any use assigned to the receiving water.
6. The discharge shall be free from oil, grease and petrochemicals that produce a visible film on the surface of the water, impart an oily taste to the water or an oily or other undesirable taste to the edible portions of aquatic life, coat the banks or bottom of the water course, or are deleterious or become toxic to aquatic life.
7. The Permittee must provide adequate notice to EPA-Region 1 and MassDEP of the following:
 - a. Any new introduction of pollutants into the facility from an indirect discharger which would be subject to Part 301 or Part 306 of the Clean Water Act if it were directly discharging those pollutants or in a primary industry category (see 40 CFR Part 122 Appendix A as amended) discharging process water; and
 - b. Any substantial change in the volume or character of pollutants being introduced into that facility by a source introducing pollutants into the facility at the time of issuance of the permit.
 - c. For purposes of this paragraph, adequate notice shall include information on:
 - (1) The quantity and quality of effluent introduced into the facility; and
 - (2) Any anticipated impact of the change on the quantity or quality of effluent to be discharged from the facility.
8. Pollutants introduced into the facility by a non-domestic source (user) shall not pass through the POTW or facility or interfere with the operation or performance of the works.
9. Total Residual Chlorine (TRC) limitations and related requirements are specified below:

- a. N/A
- b. The Permittee shall minimize the use of chlorine while maintaining adequate bacterial control. TRC monitoring and limitations only apply to discharges which have been previously chlorinated or which contain residual chlorine. If bacteria limits do not apply during a particular monitoring period and, therefore, chlorine is not utilized, TRC monitoring is not necessary and the Permittee may enter "NODI" code 9 (*i.e.*, conditional monitoring) in the relevant discharge monitoring report.
- c. Additionally, Permittees authorized to conduct disinfection using an alternative to chlorine as the disinfectant are only subject to the TRC limitations and monitoring requirements whenever chlorine is added to the treatment process for disinfection or for other purpose. For the months in which chlorine is not added to the treatment process and the Permittee may enter "NODI" code 9 (*i.e.*, conditional monitoring) in the relevant discharge monitoring report.
- d. Chlorination and dechlorination systems shall include an alarm system for indicating system interruptions or malfunctions. Any interruption or malfunction of the chlorine dosing system that may have resulted in levels of chlorine that were inadequate for achieving effective disinfection, or interruptions or malfunctions of the dechlorination system that may have resulted in excessive levels of chlorine in the final effluent shall be reported with the monthly DMRs. The report shall include the date and time of the interruption or malfunction, the nature of the problem, and the estimated amount of time that the reduced levels of chlorine or dechlorination chemicals occurred.
- e. TRC limitations, monitoring, and reporting requirements apply only during the specified disinfection period and whenever chlorine is added to the treatment process outside of the specified disinfection period.

C. Unauthorized Discharges

1. This permit authorizes discharges only from the outfall(s) listed in the authorization to discharge from EPA in accordance with the terms and conditions of this permit. Discharges of wastewater from any other point sources, including sanitary sewer overflows (SSOs), are not authorized by this permit. The Permittee must provide verbal notification to EPA within 24 hours of becoming aware of any unauthorized discharge and a report within 5 days, in accordance with Part VII.D.1.e (24-hour reporting). Providing that it contains the information required in Part VII.D.1.e, submission of the MassDEP SSO Reporting Form (described in Part II.C.3 below) may satisfy the requirement for a written report. See Part V below for reporting requirements.
2. The Permittee must provide notification to the public within 24 hours of becoming aware of any unauthorized discharge, except SSOs that do not impact a surface water or the public, on a publicly available website, and it shall remain on the website for a minimum of 12 months. Such notification shall include the location and description of the discharge; estimated volume; the period of noncompliance, including exact dates and times, and, if the noncompliance has not been corrected, the anticipated time it is expected to continue.

3. Notification of SSOs to MassDEP shall be made on its SSO Reporting Form (which includes MassDEP Regional Office telephone numbers). The reporting form and instruction for its completion may be found on-line at <https://www.mass.gov/how-to/sanitary-sewer-overflowbypassbackup-notification>.

D. Notification Requirements

The Permittee shall notify all downstream community water systems (if any) of any emergency condition, plant upset, bypass, or other system failure which has the potential to impact the quality of the water to be withdrawn by that community for drinking water purposes. This notification should be made as soon as possible but within four (4) hours, and in the anticipation of such an event, if feasible, without taking away from any response time necessary to alleviate the situation. The Permittee shall follow up with written notification within five (5) days. This notification shall include the reason for the emergency, any sampling information, any visual data recorded, a description of how the situation was handled, and when it would be considered to no longer be an emergency.

III. Additional Limitations, Conditions, and Requirements

A. Operation and Maintenance of the Sewer System

Operation and maintenance (O&M) of the sewer system shall be in compliance with the Standard Conditions of Part VII and the following terms and conditions. The Permittee and Co-permittee shall complete the following activities for the collection system which it owns:

1. Maintenance Staff

The Permittee and Co-permittee shall provide an adequate staff to carry out the operation, maintenance, repair, and testing functions required to ensure compliance with the terms and conditions of this permit. Provisions to meet this requirement shall be described in the Collection System O&M Plan required pursuant to Section III.A.5. below.

2. Preventive Maintenance Program

The Permittee and Co-permittee shall maintain an ongoing preventive maintenance program to prevent overflows and bypasses caused by malfunctions or failures of the sewer system infrastructure. The program shall include an inspection program designed to identify all potential and actual unauthorized discharges. Plans and programs to meet this requirement shall be described in the Collection System O&M Plan required pursuant to Section III.A.5. below.

3. Infiltration/Inflow

The Permittee and Co-permittee shall control infiltration and inflow (I/I) into the sewer system as necessary to prevent high flow related unauthorized discharges from their collection systems and high flow related violations of the wastewater treatment plant's effluent limitations. Plans and programs to control I/I shall be described in the Collection System O&M Plan required pursuant to Section III.A.5. below.

4. Collection System Mapping

The Permittee and Co-permittee shall continue to maintain a map of the sewer collection system it owns. The map shall be on a street map of the community, with sufficient detail and at a scale to allow easy interpretation. The collection system information shown on the map shall be based on current conditions and shall be kept up-to-date and available for review by federal, state, or local agencies. Such map(s) shall include, but not be limited to the following:

- a. All sanitary sewer lines and related manholes;
- b. All combined sewer lines, related manholes, and catch basins;
- c. All combined sewer regulators and any known or suspected connections between the sanitary sewer and storm drain systems (e.g. combination manholes);
- d. All outfalls, including the treatment plant outfall(s), CSOs, and any known or suspected SSOs, including stormwater outfalls that are connected to combination manholes;
- e. All pump stations and force mains;
- f. The wastewater treatment facility(ies);
- g. All surface waters (labeled);
- h. Other major appurtenances such as inverted siphons and air release valves;
- i. A numbering system which uniquely identifies manholes, catch basins, overflow points, regulators and outfalls;
- j. The scale and a north arrow; and
- k. The pipe diameter, date of installation, type of material, distance between manholes, and the direction of flow.

5. Collection System O&M Plan

- a. N/A
- b. N/A

The Permittee and Co-permittee shall update and implement the Collection System O&M Plan they have previously submitted to EPA and the State in accordance with Part (c) below. The plan shall be available for review by federal, state, and local agencies upon request.

- c. The Plan shall include:

- (1) A description of the collection system management goals, staffing, information management, and legal authorities;
- (2) A description of the collection system and the overall condition of the collection system including a list of all pump stations and a description of recent studies and construction activities;
- (3) A preventive maintenance and monitoring program for the collection system;
- (4) Description of sufficient staffing necessary to properly operate and maintain the sanitary sewer collection system and how the operation and maintenance program is staffed;
- (5) Description of funding, the source(s) of funding and provisions for funding sufficient for implementing the plan;
- (6) Identification of known and suspected overflows and back-ups, including manholes. A description of the cause of the identified overflows and back-ups, corrective actions taken, and a plan for addressing the overflows and back-ups consistent with the requirements of this permit;
- (7) A description of the Permittee's programs for preventing I/I related effluent violations and all unauthorized discharges of wastewater, including overflows and by-passes and the ongoing program to identify and remove sources of I/I. The program shall include an inflow identification and control program that focuses on the disconnection and redirection of illegal sump pumps and roof down spouts;
- (8) An educational public outreach program for all aspects of I/I control, particularly private inflow; and
- (9) An Overflow Emergency Response Plan to protect public health from overflows and unanticipated bypasses or upsets that exceed any effluent limitation in the permit.

6. Annual Reporting Requirement

The Permittee and Co-permittee shall submit a summary report of activities related to the implementation of its Collection System O&M Plan during the previous calendar year. The report shall be submitted to EPA and the State annually by March 31st. The summary report shall, at a minimum, include:

- a. A description of the staffing levels maintained during the year;
- b. A map and a description of inspection and maintenance activities conducted and corrective actions taken during the previous year;
- c. Expenditures for any collection system maintenance activities and corrective actions taken during the previous year;
- d. A map with areas identified for investigation/action in the coming year;
- e. A summary of unauthorized discharges during the past year and their causes and a report of any corrective actions taken as a result of the unauthorized discharges reported pursuant to the Unauthorized Discharges section of this permit; and

- f. If the average annual flow in the previous calendar year exceeded 80 percent of the facility's design flow, or there have been capacity-related overflows, the report shall include items in (1) and (2) below.

- (1) Plans for further potential flow increases describing how the Permittee will maintain compliance with the flow limit and all other effluent limitations and conditions; and
- (2) A calculation of the maximum daily, weekly, and monthly infiltration and the maximum daily, weekly, and monthly inflow for the reporting year.

B. Alternate Power Source

In order to maintain compliance with the terms and conditions of this permit, the Permittee and Co-permittee shall provide an alternative power source(s) sufficient to operate the portion of the publicly owned treatment works it owns and operates, as defined in Part VII.E.1 of this permit.

C. Industrial Users

N/A

D. Industrial Pretreatment Programs

1. The Permittee shall develop and enforce specific effluent limits (local limits) for Industrial User(s), and all other users, as appropriate, which together with appropriate changes in the POTW Treatment Plant's Facilities or operation, are necessary to ensure continued compliance with the POTW's NPDES permit or sludge use or disposal practices. Specific local limits shall not be developed and enforced without individual notice to persons or groups who have requested such notice and an opportunity to respond. Within 90 days of the effective date of the authorization to discharge under the General Permit, the Permittee shall prepare and submit a written technical evaluation to EPA analyzing the need to revise local limits. As part of this evaluation, the Permittee shall assess how the POTW performs with respect to influent and effluent of pollutants, water quality concerns, sludge quality, sludge processing concerns/inhibition, biomonitoring results, activated sludge inhibition, worker health and safety and collection system concerns. In preparing this evaluation, the Permittee shall complete and submit the attached form (see **Attachment F – Reassessment of Technically Based Industrial Discharge Limits**) with the technical evaluation to assist in determining whether existing local limits need to be revised. Justifications and conclusions should be based on actual plant data if available and should be included in the report. Should the evaluation reveal the need to revise local limits, the Permittee shall complete the revisions within 120 days of notification by EPA and submit the revisions to EPA for approval. The Permittee shall carry out the local limits revisions in accordance with EPA's Local Limit Development Guidance (July 2004).
2. The Permittee shall implement the Industrial Pretreatment Program in accordance with the legal authorities, policies, procedures, and financial provisions described in the Permittee's approved Pretreatment Program, and the General Pretreatment Regulations, 40 CFR Part 403. At a minimum, the Permittee must perform the following duties to properly implement the Industrial Pretreatment Program (IPP):

- a. Carry out inspection, surveillance, and monitoring procedures which will determine independent of information supplied by the industrial user, whether the industrial user is in compliance with the Pretreatment Standards. At a minimum, all significant industrial users shall be sampled and inspected at the frequency established in the approved IPP but in no case less than once per year and maintain adequate records.
 - b. Issue or renew all necessary industrial user control mechanisms within 90 days of their expiration date or within 180 days after the industry has been determined to be a significant industrial user.
 - c. Obtain appropriate remedies for noncompliance by any industrial user with any pretreatment standard and/or requirement.
 - d. Maintain an adequate revenue structure for continued implementation of the Pretreatment Program.
3. The Permittee shall provide EPA and MassDEP with an annual report describing the Permittee's pretreatment program activities for the twelve (12) month period ending 60 days prior to the due date in accordance with 40 CFR § 403.12(i). The annual report shall be consistent with the format described in **Attachment G** (*NPDES Permit Requirement for Industrial Pretreatment Annual Report*) of this permit and shall be submitted by **March 1** of each year.
 4. The Permittee must obtain approval from EPA prior to making any significant changes to the industrial pretreatment program in accordance with 40 CFR § 403.18(c).
 5. The Permittee must assure that applicable National Categorical Pretreatment Standards are met by all categorical industrial users of the POTW. These standards are published in the Federal Regulations at 40 CFR § 405 *et seq.*
 6. The Permittee must modify its pretreatment program, if necessary, to conform to all changes in the Federal Regulations that pertain to the implementation and enforcement of the industrial pretreatment program. Within 180 days of the effective date of the authorization to discharge under the General Permit the Permittee must provide EPA in writing, proposed changes, if applicable, to the Permittee's pretreatment program deemed necessary to assure conformity with current Federal Regulations. At a minimum, the Permittee must address in its written submission the following areas: (1) Enforcement response plan; (2) revised sewer use ordinances; and (3) slug control evaluations. The Permittee will implement these proposed changes pending EPA Region 1's approval under 40 CFR § 403.18. This submission is separate and distinct from any local limits analysis submission described in Part III.D.1.
 7. Beginning the first full calendar year after the effective date of the authorization to discharge under the General Permit, the Permittee shall commence annual sampling of the following types of industrial discharges into the POTW:
 - Commercial Car Washes
 - Platers/Metal Finishers

- Paper and Packaging Manufacturers
- Tanneries and Leather/Fabric/Carpet Treaters
- Manufacturers of Parts with Polytetrafluoroethylene (PTFE) or teflon type coatings (i.e. bearings)
- Landfill Leachate
- Centralized Waste Treaters
- Known or Suspected PFAS Contaminated Sites
- Fire Fighting Training Facilities
- Airports
- Any Other Known or Expected Sources of PFAS

Until there is an analytical method approved in 40 CFR Part 136 for PFAS, monitoring shall be conducted using Draft Method 1633. Sampling shall be for the PFAS analytes required to be tested in Method 1633, as shown in Attachment E.

The industrial discharges sampled and the sampling results (including the full lab report) shall be summarized and included in the annual report (see Part III.D.3).

E. Sludge Conditions

1. The Permittee shall comply with all existing federal and state laws and regulations that apply to sewage sludge use and disposal practices, including EPA regulations promulgated at 40 CFR Part 503, which prescribe “Standards for the Use or Disposal of Sewage Sludge” pursuant to § 405(d) of the CWA, 33 U.S.C. § 1345(d).
2. If both state and federal requirements apply to the Permittee’s sludge use and/or disposal practices, the Permittee shall comply with the more stringent of the applicable requirements.
3. The requirements and technical standards of 40 CFR Part 503 apply to the following sludge use or disposal practices:
 - a. Land application - the use of sewage sludge to condition or fertilize the soil
 - b. Surface disposal - the placement of sewage sludge in a sludge only landfill
 - c. Sewage sludge incineration in a sludge only incinerator
4. The requirements of 40 CFR Part 503 do not apply to facilities which dispose of sludge in a municipal solid waste landfill. 40 CFR § 503.4. These requirements also do not apply to facilities which do not use or dispose of sewage sludge during the life of the permit but rather treat the sludge (e.g., lagoons, reed beds), or are otherwise excluded under 40 CFR § 503.6.
5. The 40 CFR Part 503 requirements include the following elements:
 - General requirements
 - Pollutant limitations
 - Operational Standards (pathogen reduction requirements and vector attraction reduction requirements)

- Management practices
- Record keeping
- Monitoring
- Reporting

Which of the 40 CFR Part 503 requirements apply to the Permittee will depend upon the use or disposal practice followed and upon the quality of material produced by a facility. The EPA Region 1 Guidance document, “EPA Region 1 - NPDES Permit Sludge Compliance Guidance” (November 4, 1999), may be used by the Permittee to assist it in determining the applicable requirements.¹

6. The sludge shall be monitored for pollutant concentrations (all Part 503 methods) and pathogen reduction and vector attraction reduction (land application and surface disposal) at the following frequency. This frequency is based upon the volume of sewage sludge generated at the facility in dry metric tons per year, as follows:

less than 290	1/ year
290 to less than 1,500	1 /quarter
1,500 to less than 15,000	6 /year
15,000 +	1 /month

Sampling of the sewage sludge shall use the procedures detailed in 40 CFR § 503.8.

7. Under 40 CFR § 503.9(r), the Permittee is a “person who prepares sewage sludge” because it “is ... the person who generates sewage sludge during the treatment of domestic sewage in a treatment works” If the Permittee contracts with *another* “person who prepares sewage sludge” under 40 CFR § 503.9(r) – i.e., with “a person who derives a material from sewage sludge” – for use or disposal of the sludge, then compliance with Part 503 requirements is the responsibility of the contractor engaged for that purpose. If the Permittee does not engage a “person who prepares sewage sludge,” as defined in 40 CFR § 503.9(r), for use or disposal, then the Permittee remains responsible to ensure that the applicable requirements in Part 503 are met. 40 CFR § 503.7. If the ultimate use or disposal method is land application, the Permittee is responsible for providing the person receiving the sludge with notice and necessary information to comply with the requirements of 40 CFR § 503 Subpart B.
8. The Permittee shall submit an annual report containing the information specified in the 40 CFR Part 503 requirements (§ 503.18 (land application), § 503.28 (surface disposal), or § 503.48 (incineration)) by February 19 (see also “EPA Region 1 - NPDES Permit Sludge Compliance Guidance”). Reports shall be submitted electronically using EPA’s Electronic Reporting tool

¹ This guidance document is available upon request from EPA Region 1 and may also be found at:
<http://www3.epa.gov/region1/npdes/permits/generic/sludgeguidance.pdf>

(“NeT”) (see “Reporting Requirements” section below).

F. Schedules of Compliance

1. The Permittee will have a schedule of compliance of 24 months for the total nitrogen limit. During the compliance schedule, the Permittee shall report monitoring results.
2. Within twelve (12) months of the effective date of the authorization to discharge under the General Permit, the Permittee shall submit to EPA and MassDEP a status report relative to the process improvements necessary to achieve the new total nitrogen permit limit.

G. Additional Requirements for Facilities Discharging to the Long Island Sound Watershed, the Blackstone River Watershed, the Taunton River Watershed, as well as the Plymouth WWTP and Fairhaven WPCF

1. The Permittee shall continue to optimize the treatment facility operations relative to total nitrogen (TN) removal through measures and/or operational changes designed to enhance the removal of nitrogen in order to minimize the annual average mass discharge of total nitrogen.
2. The Permittee shall submit an annual report to EPA and the State, by February 1st of each year, that summarizes activities related to optimizing nitrogen removal efficiencies, documents the annual nitrogen discharge load from the facility, and tracks trends relative to the previous calendar year and the previous five (5) calendar years. If, in any year, the treatment facility discharges of TN on an average annual basis have increased, the annual report shall include a detailed explanation of the reasons why TN discharges have increased, including any changes in influent flows/loads and any operational changes. The report shall include all supporting data.

H. Submittal of Facility-Specific Information

Each permittee shall perform three full pollutant scans consistent with the requirements of NPDES Form 2A, Tables B and C, using a representative composite sample once per quarter in the final 3 full calendar quarters of the 5-year permit term. The results for all three scans shall be summarized and submitted as a single electronic attachment to the DMR for the final full calendar quarter before the expiration date of the General Permit (in accordance with Part V.2 below). This submittal shall also include the following information that EPA has deemed necessary for development of the next reissuance of this General Permit:

- Provide the current average daily volume of inflow and infiltration (I/I)
- Provide an updated Flow Diagram or Schematic for the WWTF
- Provide a summary and schedule for any ongoing or planned facility upgrades
- Provide a list of Significant Industrial Users and Categorical Industrial Users contributing flow to the system (including average volume contributed from each)
- Provide a summary of sewage sludge treatment and disposal practices (including disposal method, disposal amount in dry metric tons, name and address of any third-party contractor, etc.).

I. State 401 Certification Conditions

This Permit has received state water quality certification issued by the State under § 401(a) of the CWA and 40 CFR § 124.53. EPA incorporates the following state water quality certification requirements into the Final Permit:

1. Notwithstanding any other provision of the 2022 Federal NPDES Permit to the contrary, monitoring results of the influent, effluent, and sludge for PFAS compounds shall be reported to MassDEP electronically, at massdep.npdes@mass.gov, or as otherwise specified, within 30 days after they are received.
2. Pursuant to M.G.L. c. 21, §§ 26-53, and 314 CMR 3.00 and 4.00, including 314 CMR 3.11(2)(a)6., and in order to ensure the maintenance of surface waters free from pollutants in concentrations or combinations that are toxic to humans, aquatic life, or wildlife, in accordance with 314 CMR 4.05(5)(e), MassDEP has determined that it is necessary that the permittee commence annual monitoring of all Significant Industrial Users^{2,3} discharging into the POTW consistent with the 2022 NPDES General Permit in accordance with the table below. Notwithstanding any other provision of the 2022 NPDES General Permit to the contrary, monitoring results shall be reported to MassDEP electronically at massdep.npdes@mass.gov within 30 days after they are received.

Parameter	Units	Measurement Frequency	Sample Type
Perfluorohexanesulfonic acid (PFHxS)	ng/L	Annual	24-hour Composite
Perfluoroheptanoic acid (PFHpA)	ng/L	Annual	24-hour Composite
Perfluorononanoic acid (PFNA)	ng/L	Annual	24-hour Composite
Perfluorooctanesulfonic acid (PFOS)	ng/L	Annual	24-hour Composite
Perfluorooctanoic acid (PFOA)	ng/L	Annual	24-hour Composite
Perfluorodecanoic acid (PFDA)	ng/L	Annual	24-hour Composite

² Significant Industrial User (SIU) is defined at 40 CFR part 403: All industrial users subject to Categorical Pretreatment Standards under 40 CFR 403.6 and 40 CFR chapter I, subpart N; **and** any other industrial user that: discharges an average of 25,000 GPD or more of process wastewater to the POTW, contributes a process wastestream that makes up 5% or more of the average dry weather hydraulic or organic capacity of the POTW, or designated as such by the POTW on the basis that the industrial users has a reasonable potential for adversely affecting the POTW's operation or for violating any Pretreatment Standards or requirement.

³ This requirement applies to all Significant Industrial Users and not just those within the sectors identified by EPA in the NPDES permit.

IV. Obtaining Authorization to Discharge

N/A

V. Monitoring, Record-Keeping, and Reporting Requirements

Unless otherwise specified in this permit, the Permittee shall submit reports, requests, and information and provide notices in the manner described in this section.

1. Submittal of DMRs Using NetDMR

The Permittee shall continue to submit its monthly monitoring data in discharge monitoring reports (DMRs) to EPA and MassDEP no later than the 15th day of the month electronically using NetDMR. When the Permittee submits DMRs using NetDMR, it is not required to submit hard copies of DMRs to EPA or MassDEP. NetDMR is accessible through EPA's Central Data Exchange at <https://cdx.epa.gov/>.

2. Submittal of Reports as NetDMR Attachments

Unless otherwise specified in this permit, the Permittee and Co-permittee shall electronically submit all reports to EPA and MassDEP as NetDMR attachments rather than as hard copies. See Part V.5 for more information on State reporting. Because the due dates for reports described in this permit may not coincide with the due date for submitting DMRs (which is no later than the 15th day of the month), a report submitted electronically as a NetDMR attachment shall be considered timely if it is electronically submitted to EPA using NetDMR with the next DMR due following the report due date specified in this permit.

3. Submittal of Industrial User and Pretreatment Related Reports

- a. Prior to 21 December 2025, all reports and information required of the Permittee in the Industrial Users and Pretreatment Program section of this permit shall be submitted to the Pretreatment Coordinator in EPA Region 1 Water Division (WD). Starting on 21 December 2025, these submittals must be done electronically as NetDMR attachments and/or using EPA's NPDES Electronic Reporting Tool ("NeT"), or another approved EPA system, which will be accessible through EPA's Central Data Exchange at <https://cdx.epa.gov/>. These requests, reports and notices include:

- (1) Annual Pretreatment Reports,
- (2) Pretreatment Reports Reassessment of Technically Based Industrial Discharge Limits Form,
- (3) Revisions to Industrial Discharge Limits,
- (4) Report describing Pretreatment Program activities, and
- (5) Proposed changes to a Pretreatment Program

- b. This information shall be submitted to EPA WD as a hard copy at the following address:

**U.S. Environmental Protection Agency
Water Division
Regional Pretreatment Coordinator
5 Post Office Square - Suite 100 (06-03)
Boston, MA 02109-3912**

4. Submittal of Biosolids/Sewage Sludge Reports

By February 19 of each year, the Permittee must electronically report their annual Biosolids/Sewage Sludge Report for the previous calendar year using EPA's NPDES Electronic Reporting Tool ("NeT"), or another approved EPA system, which is accessible through EPA's Central Data Exchange at <https://cdx.epa.gov/>.

5. Submittal of Requests and Reports to EPA Water Division (WD)

- a. The following requests, reports, and information described in this permit shall be submitted to the NPDES Applications Coordinator in EPA Water Division (WD):

- (1) Transfer of permit notice;
- (2) Request for changes in sampling location;
- (3) Request for reduction in testing frequency;
- (4) Request for change in WET testing requirement; and
- (5) Report on unacceptable dilution water / request for alternative dilution water for WET testing.
- (6) Report of new industrial user commencing discharge
- (7) Report received from existing industrial user
- (8) Request for extension of compliance schedule

- b. These reports, information, and requests shall be submitted to EPA WD electronically at R1NPDESReporting@epa.gov.

6. Submittal of Sewer Overflow and Bypass Reports and Notices

The Permittee shall submit required reports and notices under Part VII.B.4.c, for bypasses, and Part VII.D.1.e, for sanitary sewer overflows (SSOs) electronically using EPA's NPDES Electronic Reporting Tool ("NeT"), which will be accessible through EPA's Central Data Exchange at <https://cdx.epa.gov/>.

7. State Reporting

Duplicate signed copies of all WET test reports shall be submitted to the Massachusetts Department of Environmental Protection, Division of Watershed Management, at the following address:

Massachusetts Department of Environmental Protection
Bureau of Water Resources
Division of Watershed Management

8 New Bond Street
Worcester, Massachusetts 01606

8. Verbal Reports and Verbal Notifications

- a. Any verbal reports or verbal notifications, if required in Parts I through VII of this General Permit, shall be made to both EPA and to MassDEP. This includes verbal reports and notifications which require reporting within 24 hours (e.g., Part VII.B.4.c.(2), Part VII.B.5.c.(3), and Part VII.D.1.e).
- b. Verbal reports and verbal notifications shall be made to:

EPA ECAD at 617-918-1510
and
MassDEP's Emergency Response at 888-304-1133

VI. Administrative Requirements

A. Notice of Termination (NOT) of Discharge or Change of Owner/Operator

Permittees shall notify EPA and the appropriate State agency in writing upon the termination of any discharge(s) authorized by this General Permit. The NOT shall include the name, mailing address, phone number, and the location of the facility for which the notification is being submitted, the NPDES permit number of the discharge identified by the notice, and an indication of whether the discharge has been eliminated or if the owner/operator of the discharge has changed. The NOT shall be signed in accordance with the signatory requirements of 40 CFR § 122.22. Completed and signed NOTs shall be submitted to EPA at R1NPDESReporting@epa.gov and to MassDEP at MassDEP.NPDES@mass.gov.

B. Continuation of this General Permit After Expiration

If this General Permit is not reissued prior to its expiration date, it will be administratively continued in accordance with the Administrative Procedures Act (5 U.S.C. 558(c)) and 40 CFR § 122.6 and remain in full force and in effect for discharges covered prior to its expiration.

Coverage under this permit will not be available to any facility that is not authorized to discharge under the General Permit before the expiration date.

Any Permittee whose authorization to discharge under this General Permit was administratively continued will automatically remain covered by the continued General Permit until the earlier of:

1. Authorization to discharge under a reissued permit or a replacement of this permit; or
2. The Permittee's submittal of a Notice of Termination; or
3. Issuance of an individual permit for the Permittee's discharge; or
4. A formal permit decision by EPA not to reissue this General Permit, at which time EPA will identify a reasonable time period for covered dischargers to seek coverage under an

alternative general permit or an individual permit. Coverage under this permit will cease at the end of this time period.

Appendix B: Biowin™ Modeling Results

South Hadley
MLE Process Configuration
11/20/2025

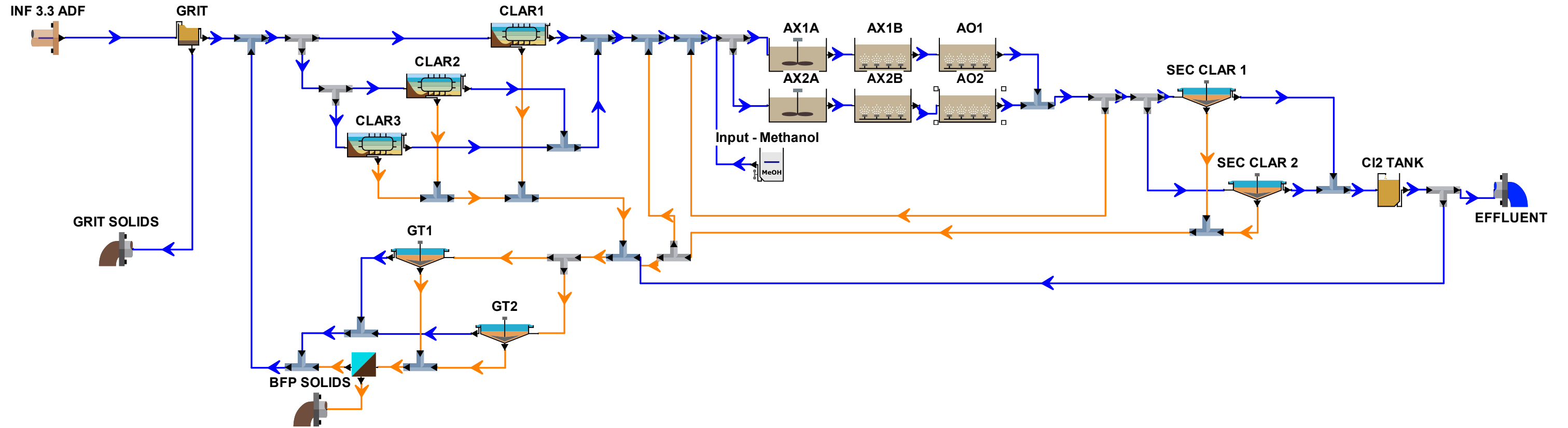

South Hadley
 MLE Process Configuration
 3.3 MGD @ 10C
 11/20/2025

Table

Elements	Flow [mgd]	Temperature [deg. C]	BOD - Total Carbonaceous [mg/L]	Total suspended solids [mg/L]	N - Nitrate [mgN/L]	N - Nitrite [mgN/L]	N - Ammonia [mgN/L]	N - Total Kjeldahl Nitrogen [mgN/L]	N - Total N [mgN/L]
INF 3.3 ADF	3.30	10.00	117.00	163.51	0	0	20.14	30.52	30.52
POST PRI CLAR MIX	3.68	10.00	80.01	89.84	0.60	0.05	18.17	26.72	27.37
Input - Methanol	0	10.00	926,072.51	0	0	0	0	0	0
AX1A	10.07	10.00	698.54	2,822.61	3.40	0.43	4.44	179.21	183.04
AX1B	10.07	10.00	696.75	2,821.75	2.55	0.37	4.71	179.20	182.12
AO1	10.07	10.00	690.98	2,816.57	5.74	0.48	1.23	175.71	181.92
SEC CLAR 1	1.82	10.00	3.56	10.73	5.74	0.48	1.23	3.08	9.29
SEC CLAR 1 (U)	1.65	10.00	1,451.09	5,919.16	5.74	0.48	1.23	366.60	372.81
EFFLUENT	3.25	10.00	3.56	10.73	5.74	0.48	1.23	3.08	9.29

South Hadley
 MLE Process Configuration
 3.3 MGD @ 20C
 11/20/2025

Table

Elements	Flow [mgd]	Temperature [deg. C]	BOD - Total Carbonaceous [mg/L]	Total suspended solids [mg/L]	N - Nitrate [mgN/L]	N - Nitrite [mgN/L]	N - Ammonia [mgN/L]	N - Total Kjeldahl Nitrogen [mgN/L]	N - Total N [mgN/L]
INF 3.3 ADF	3.30	20.00	117.00	163.51	0	0	20.14	30.52	30.52
POST PRI CLAR MIX	3.68	20.00	79.20	88.95	0.67	0.01	18.09	26.56	27.24
Input - Methanol	0	20.00	926,072.51	0	0	0	0	0	0
AX1A	10.07	20.00	564.78	2,673.14	3.80	0.25	3.74	165.26	169.31
AX1B	10.07	20.00	562.92	2,672.15	2.89	0.22	4.01	165.25	168.36
AO1	10.07	20.00	556.89	2,666.68	6.39	0.13	0.44	161.64	168.16
SEC CLAR 1	1.82	20.00	3.03	10.16	6.39	0.13	0.44	2.23	8.74
SEC CLAR 1 (U)	1.65	20.00	1,169.32	5,604.14	6.39	0.13	0.44	337.92	344.44
EFFLUENT	3.25	20.00	3.03	10.16	6.39	0.13	0.44	2.23	8.74

South Hadley
 MLE Process Configuration
 5.3 MGD @ 10C
 11/20/2025

Table

Elements	Flow [mgd]	Temperature [deg. C]	BOD - Total Carbonaceous [mg/L]	Total suspended solids [mg/L]	N - Nitrate [mgN/L]	N - Nitrite [mgN/L]	N - Ammonia [mgN/L]	N - Total Kjeldahl Nitrogen [mgN/L]	N - Total N [mgN/L]
INF 5.3 MM	5.30	10.00	114.02	248.86	0	0	16.43	24.89	24.89
POST PRI CLAR MIX	5.70	10.00	82.56	117.10	0.04	0.13	15.41	22.91	23.08
Input - Methanol	0	10.00	926,072.51	0	0	0	0	0	0
AX1A	16.07	10.00	981.92	4,185.23	0.04	0.67	4.61	205.60	206.31
AX1B	16.07	10.00	980.40	4,185.09	0.00	0.06	4.86	205.59	205.66
AO1	16.07	10.00	974.88	4,180.52	0.59	1.81	2.15	203.06	205.47
SEC CLAR 1	2.82	10.00	4.87	16.21	0.59	1.81	2.15	3.98	6.39
SEC CLAR 1 (U)	2.65	10.00	2,008.77	8,619.06	0.59	1.81	2.15	415.25	417.66
EFFLUENT	5.25	10.00	4.87	16.21	0.59	1.81	2.15	3.98	6.39

South Hadley
 MLE Process Configuration
 5.3 MGD @ 20C
 11/20/2025

Table

Elements	Flow [mgd]	Temperature [deg. C]	BOD - Total Carbonaceous [mg/L]	Total suspended solids [mg/L]	N - Nitrate [mgN/L]	N - Nitrite [mgN/L]	N - Ammonia [mgN/L]	N - Total Kjeldahl Nitrogen [mgN/L]	N - Total N [mgN/L]
INF 5.3 MM	5.30	20.00	114.02	248.86	0	0	16.43	24.89	24.89
POST PRI CLAR MIX	5.70	20.00	81.30	115.63	0.21	0.01	15.30	22.66	22.89
Input - Methanol	0	20.00	926,072.51	0	0	0	0	0	0
AX1A	16.07	20.00	773.91	3,942.34	1.19	0.20	3.15	183.02	184.41
AX1B	16.07	20.00	772.25	3,941.67	0.49	0.10	3.38	183.02	183.61
AO1	16.07	20.00	766.67	3,936.61	2.98	0.19	0.54	180.26	183.42
SEC CLAR 1	2.82	20.00	3.95	15.26	2.98	0.19	0.54	2.28	5.45
SEC CLAR 1 (U)	2.65	20.00	1,579.62	8,116.18	2.98	0.19	0.54	369.95	373.12
EFFLUENT	5.25	20.00	3.95	15.26	2.98	0.19	0.54	2.28	5.45

South Hadley
Cyclical Aeration Configuration
11/18/2025

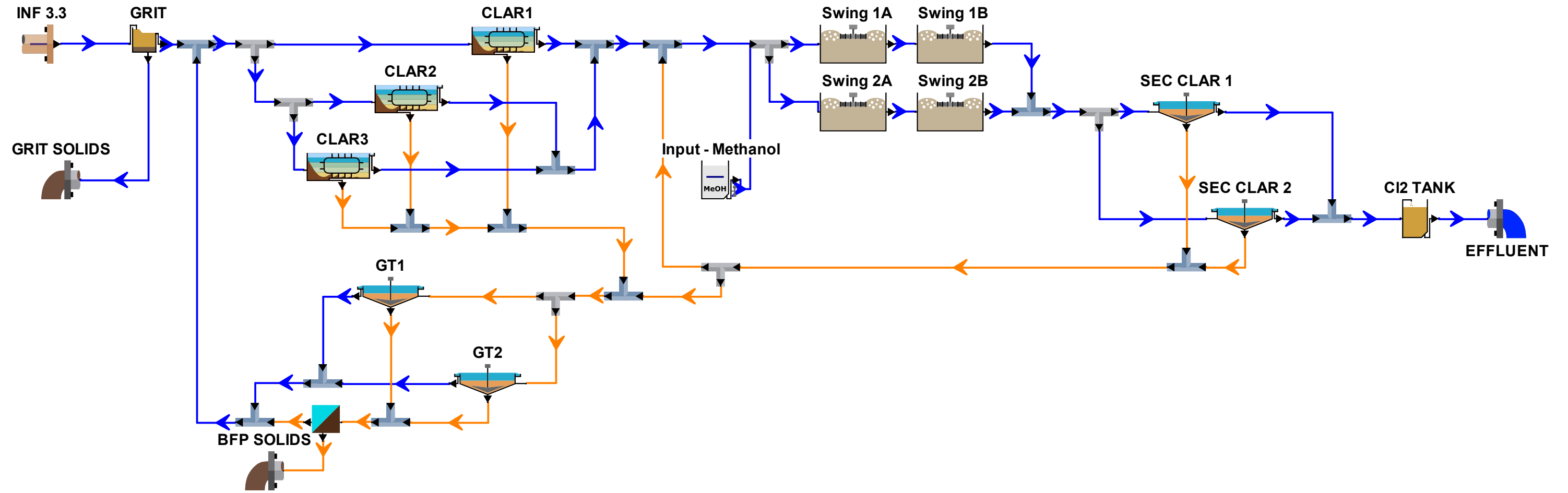

South Hadley
 Cyclical Aeration Configuration
 3.3 MGD @ 10C
 0.8% Waste
 11/20/2025

Table

Elements	Flow [mgd]	Temperature [deg. C]	BOD - Total Carbonaceous [mg/L]	Total suspended solids [mg/L]	N - Nitrate [mgN/L]	N - Nitrite [mgN/L]	N - Ammonia [mgN/L]	N - Total Kjeldahl Nitrogen [mgN/L]	N - Total N [mgN/L]
INF 3.3	3.30	10.00	117.00	163.51	0	0	20.14	30.52	30.52
POST PRI CLAR MIX	3.28	10.00	88.00	98.34	0.00	0.00	20.14	29.40	29.40
Input - Methanol	0	10.00	926,072.51	0	0	0	0	0	0
Swing 1A	3.28	10.00	714.68	3,400.77	1.23	0.21	8.47	215.40	216.84
Swing 1B	3.28	10.00	696.93	3,385.64	9.27	0.15	0.62	207.05	216.47
SEC CLAR 1	1.63	10.00	3.54	13.63	7.66	0.42	1.44	3.37	11.45
SEC CLAR 1 (U)	1.65	10.00	1,381.29	6,714.37	9.32	0.14	0.58	408.79	418.24
EFFLUENT	3.26	10.00	3.54	13.63	7.64	0.42	1.44	3.37	11.44

South Hadley
 Cyclical Aeration Configuration
 3.3 MGD @ 20C
 11/20/2025

Table

Elements	Flow [mgd]	Temperature [deg. C]	BOD - Total Carbonaceous [mg/L]	Total suspended solids [mg/L]	N - Nitrate [mgN/L]	N - Nitrite [mgN/L]	N - Ammonia [mgN/L]	N - Total Kjeldahl Nitrogen [mgN/L]	N - Total N [mgN/L]
INF 3.3	3.30	20.00	117.00	163.51	0	0	20.14	30.52	30.52
POST PRI CLAR MIX	3.28	20.00	87.83	98.83	0.00	0.00	20.14	29.42	29.42
Input - Methanol	0	20.00	926,072.51	0	0	0	0	0	0
Swing 1A	3.28	20.00	558.85	2,817.30	1.86	0.15	7.86	177.74	179.76
Swing 1B	3.28	20.00	540.99	2,801.83	9.76	0.07	0.29	169.60	179.44
SEC CLAR 1	1.63	20.00	2.90	11.29	8.55	0.26	0.75	2.52	11.33
SEC CLAR 1 (U)	1.65	20.00	1,070.97	5,550.99	9.78	0.07	0.28	334.54	344.39
EFFLUENT	3.25	20.00	2.90	11.29	8.54	0.26	0.76	2.53	11.33

South Hadley
 Cyclical Aeration Configuration
 5.3 MGD @ 10C
 11/18/2025

Table

Elements	Flow [mgd]	Temperature [deg. C]	BOD - Total Carbonaceous [mg/L]	Total suspended solids [mg/L]	N - Nitrate [mgN/L]	N - Nitrite [mgN/L]	N - Ammonia [mgN/L]	N - Total Kjeldahl Nitrogen [mgN/L]	N - Total N [mgN/L]
INF 5.3	5.30	10.00	114.02	248.86	0	0	16.43	24.89	24.89
POST PRI CLAR MIX	5.30	10.00	87.65	124.73	0.03	0.00	16.39	24.28	24.31
Input - Methanol	0	10.00	926,072.51	0	0	0	0	0	0
Swing 1A	5.27	10.00	946.04	4,280.34	0.01	0	8.84	212.08	212.09
Swing 1B	5.27	10.00	927.24	4,266.32	5.59	0.44	1.39	204.77	210.79
SEC CLAR 1	2.62	10.00	4.62	17.15	4.15	0.66	2.11	3.94	8.74
SEC CLAR 1 (U)	2.65	10.00	1,840.58	8,474.41	5.58	0.43	1.35	404.25	410.26
EFFLUENT	5.25	10.00	4.62	17.15	4.13	0.66	2.12	3.94	8.74

South Hadley
 Cyclical Aeration Configuration
 5.3 MGD @ 20C
 11/18/2025

Table

Elements	Flow [mgd]	Temperature [deg. C]	BOD - Total Carbonaceous [mg/L]	Total suspended solids [mg/L]	N - Nitrate [mgN/L]	N - Nitrite [mgN/L]	N - Ammonia [mgN/L]	N - Total Kjeldahl Nitrogen [mgN/L]	N - Total N [mgN/L]
INF 5.3	5.30	20.00	114.02	248.86	0	0	16.43	24.89	24.89
POST PRI CLAR MIX	5.30	20.00	86.61	123.53	0.03	0.00	16.39	24.17	24.20
Input - Methanol	0	20.00	926,072.51	0	0	0	0	0	0
Swing 1A	5.27	20.00	780.52	4,092.29	0.02	0.00	7.97	194.78	194.80
Swing 1B	5.27	20.00	761.37	4,077.25	6.27	0.13	0.47	187.26	193.66
SEC CLAR 1	2.62	20.00	3.89	16.39	5.38	0.24	0.81	2.56	8.17
SEC CLAR 1 (U)	2.65	20.00	1,511.19	8,098.86	6.25	0.13	0.45	370.43	376.80
EFFLUENT	5.25	20.00	3.89	16.39	5.37	0.24	0.81	2.56	8.17

Appendix C: Materials from Public Meetings

Andrea Miles, Chair
Jeff Cyr, Vice Chair
Carol Constant, Clerk
Renee Sweeney
Nicole Casolari

Lisa Wong
Town Administrator

HYBRID SELECTBOARD MEETING AGENDA

TUESDAY, SEPT. 24, 2024

SOUTH HADLEY SENIOR MULTI- PURPOSE ROOM - 7 P.M.

Join Zoom Webinar from your computer: [https://us02web.zoom.us/j/86324987662?
pwd=1YKJbcDlb1VvJGPW3t7NpuXa7n1p6a.1](https://us02web.zoom.us/j/86324987662?pwd=1YKJbcDlb1VvJGPW3t7NpuXa7n1p6a.1)

By phone: +1 646 558 8656 | **Webinar ID:** 863 2498 7662 |
Passcode: 487081

Watch live on SHCTV Channel 15 or <https://shctv15.com/watch-live/>

Note: Not all topics listed here may be reached for discussion. In addition, the topics listed are those which the chair reasonably expects will be discussed as of the date of this notice. This meeting may be audio and/or visually recorded.

1. CALL TO ORDER

2. ANNOUNCEMENTS / PUBLIC COMMENT

3. APPROVAL OF MINUTES

Draft Minutes of Sept. 10, 2024

Documents:

[DRAFT SEPT. 10, 2024 SELECTBOARD MEETING MINUTES.PDF](#)

4. 7:05 P.m. - PUBLIC HEARING (Continued) – 3 Corners Package Store, 460 Amherst Rd

Documents:

[MEMO HEARING 460 AMHERST ROAD.DOCX.PDF](#)

5. 7:10 P.M. - PUBLIC HEARING – Liquor License Transfer: 460 Amherst Rd

Documents:

[VJS CONVENIENCE TRANSFER.PDF](#)

6. 7:15 P.m. - Sen. Jacob R. Oliveira & Rep. Daniel R. Carey

7. CONSENT AGENDA

- A. Multiple One-Day Beer & Wine License requests from Robert Adam for Oct. 17 & 25
- B. Multiple One-Day All Alcohol license requests from Steve McCray for Sept. 28, Oct. 4, 5, 6, 11, 12, 13, 14, 18, 19, 20, 25, & 26
- C. Multiple One-Day Beer & Wine License requests from Elizabeth Sawyer for Oct. 9 & 23
- D. Multiple One-Day Beer & Wine License requests from Jeff Millard for Oct. 11, Nov. 8 & Dec. 13

Documents:

[OD-149.PDF](#)
[OD-146.PDF](#)
[OD-147.PDF](#)
[OD-148.PDF](#)

8. NEW BUSINESS

- A. CWMP presentation by BETA
- B. Trash/Recycling Carts
- C. Dangerous and Nuisance Dog Bylaw
- D. Ledges Quarterly Finance Report
- E. MSBA Certification
- F. ARPA Funding & SHOWCASE
- G. Opioid Funding Request
- H. Town Administrator PBE
- I. Master Plan Forum representation
- J. Special Town Meeting location
- K. Selectboard Dates
- L. Streetlight Request - Pole 74 on Newton Street

Documents:

[A. BETA GROUP, INC. - SOUTH HADLEY, MA - CWMP.PDF](#)
[B. SELECTBOARD 92524 CARTS INFO.PDF](#)
[B. TRASH CARTS PRICING FALL 2024.PDF](#)
[C. DOG BYLAW ARTICLE.PDF](#)
[D. LEDGES GOLF CLUB APRIL-JULY 2023 V 2024 COMPARISON.PDF](#)
[E. SOUTH HADLEY MOSIER ES ENR LETTER.PDF](#)
[E. SOUTH HADLEY STUDY ENROLLMENT CERT.PDF](#)
[F. SHCC FUNDING PROPOSAL - 2025-6 \(REVISED\).PDF](#)

F. AUGUST 2024 ARPA 9-11-24,XLSX - SHEET1 (1).PDF
G. MEMO OPIOID FUND REQUEST COALITION.PDF
H. LWONG PBE FY25.DOCX.PDF
I. MASTER PLAN ANNUAL FORUM.PDF
J. MEMO 2024 SPECIAL TOWN MEETING LOCATION.DOCX (1).PDF
K. MEMO SELECTBOARD MEETING DATES.PDF

9. OLD BUSINESS

A. Selectboard Action Plan

Documents:

A. SELECTBOARD ACTION ITEMS (NOT PRIORITIZED) FY2025.DOCX (1).PDF

10. RESIGNATIONS

A. Preston Smith - Associate Planning Board Member (2026)

11. TOWN ADMINISTRATOR'S REPORT

Documents:

2024 09 TA REPORT SUPPLEMENT.DOCX.PDF

12. ADJOURN

Comprehensive Wastewater Management Plan

South Hadley, MA
Selectboard Meeting

September 24, 2024



Comprehensive Wastewater Management Plan (CWMP)

- ❑ BETA was retained in March to develop the CWMP
- ❑ 20-year planning document that evaluates of current and future Town wide wastewater needs
 - To qualify for Federal of State funding, projects have to be recommended in a CWMP
- ❑ Project is being completed in three phases
 - Needs Analysis
 - Evaluation of alternatives to address identified need
 - Assessment of Environmental Impacts of the recommended plan

Comprehensive Wastewater Management Plan (CWMP)

❑ Needs Analysis:

- Collection system
 - Infiltration/Inflow (I/I)
 - Possible system expansion
 - Failing on-site wastewater disposal systems (OWTS)
 - Pumping stations
- Water Pollution Control Facility (WPCF)
 - Ability to meet permit requirements (NPDES Permit)
 - Conditions of liquid process equipment
 - Conditions of solids handling equipment

Comprehensive Wastewater Management Plan (CWMP) – Cont.

- ❑ Evaluation of alternatives
 - Cost-benefit analysis

- ❑ Environmental Assessment
 - Massachusetts Environmental Policy Act (MEPA)

Collection System Expansion

- ❑ Five problem areas (identified in 2001 CWMP)
 1. Hadley Street (north of Bachelor Brook)
 2. Pearl Street
 3. Amherst Road area
 4. East Street
 5. Cove Island & River Road
- ❑ Includes approximately 125 of homes affected by problem OWTS
- ❑ Existing issues due to natural limitations such as ledge, high groundwater table, and soils with drainage limitations

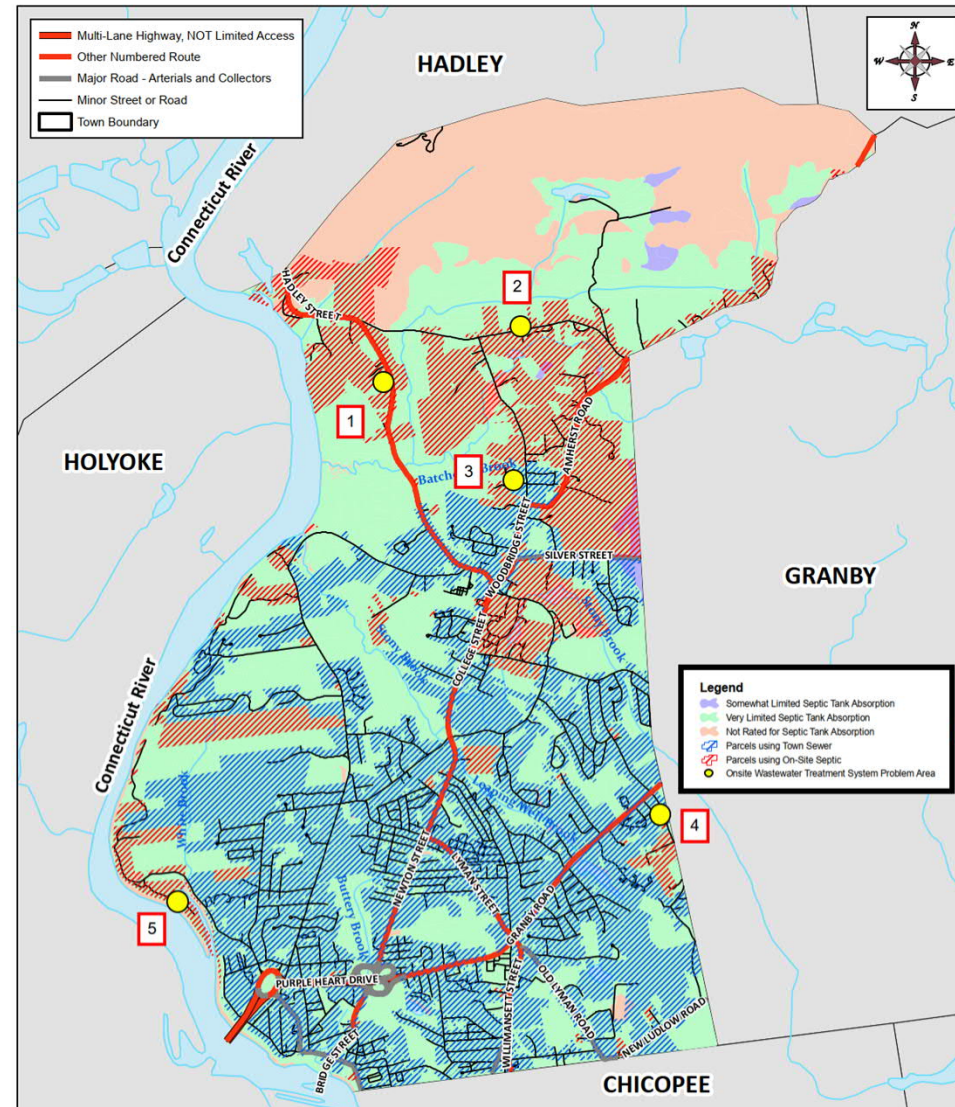

Collection System

Existing Wastewater Flows

- ❑ System consists of approximately 75 miles of pipe that services approximately 95% of South Hadley
 - Includes approximately 300 properties in Granby and 300 properties in Chicopee

- ❑ Metered water consumption
 - FD#1: 0.84 mgd
 - FD#2: 0.28 mgd
 - Granby/Chicopee: 0.06 mgd
1.18 mgd

- ❑ Actual WWTF Flow 2.64 mgd (dry season)
3.00 mgd (wet season)

- ❑ Indicates high Infiltration/Inflow rates
 - Infiltration - groundwater entering sewers
 - Inflow – rainfall related sources - storm drains, property drains, roof leaders, and sump pumps

- ❑ 67 of the 1,298 properties inspected have sump pumps connected to the sewer system

2023 Treatment Facility Flow Summary (Estimated I/I)		
Flow Contribution	Average Daily Dry Season Flow (MGD)	Average Daily Wet Season Flow (MGD)
Fire District #1 Water Consumption		0.84
Fire District #2 Water Consumption		0.28
WW Flow from Granby & Chicopee		0.06
Septage		0.00
Average Daily Flow	2.64	3.00
Estimated Infiltration/Inflow	1.46	1.82

Wastewater Pump Station Evaluation

- ☐ Main Street Pump Station
 - Wet/Dry well Station (dry pit pumps)
- ☐ Stony Brook Pump Station
 - Submersible Station
- ☐ Morgan Street Pump Station
 - Suction Lift Station
- ☐ Old Sycamore Pump Station
 - Pneumatic Ejector Station
- ☐ Topors Pump Station
 - Pneumatic Ejector Station

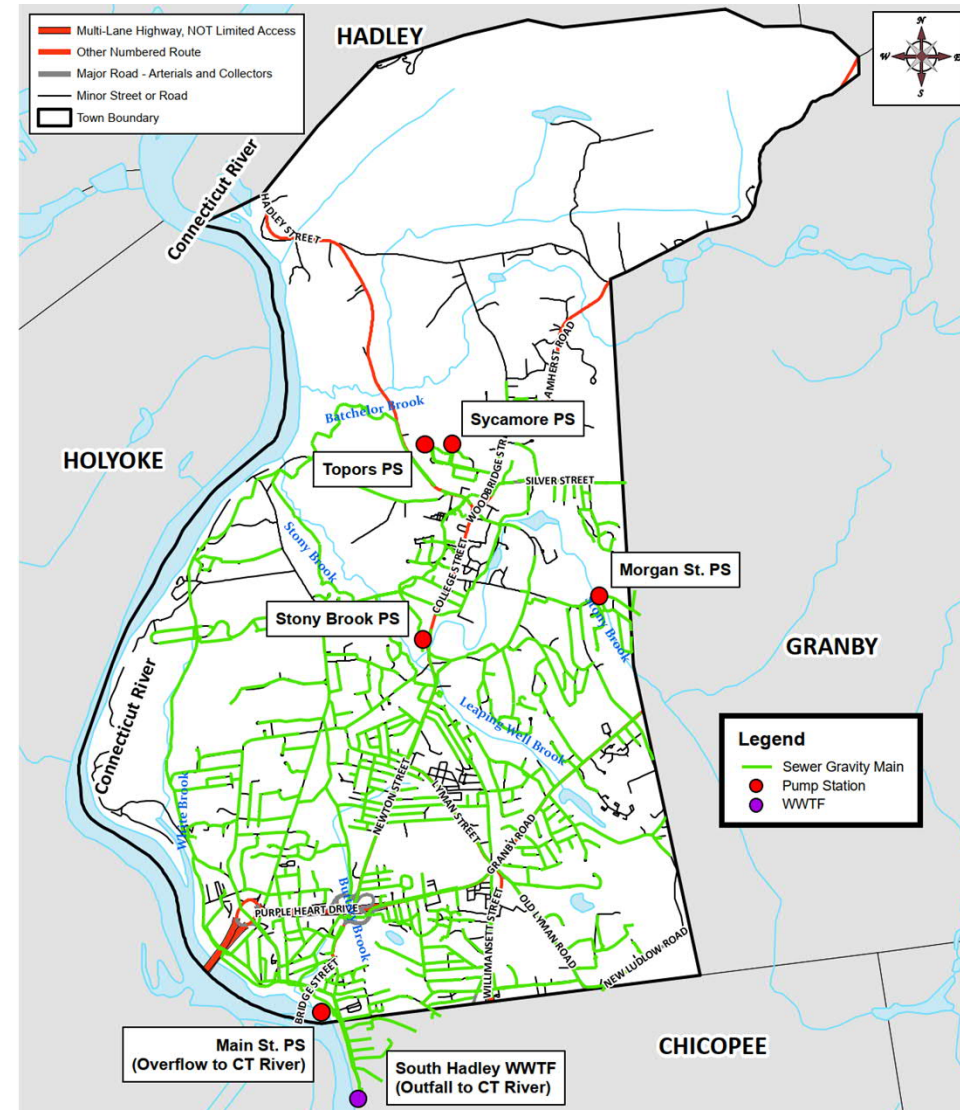

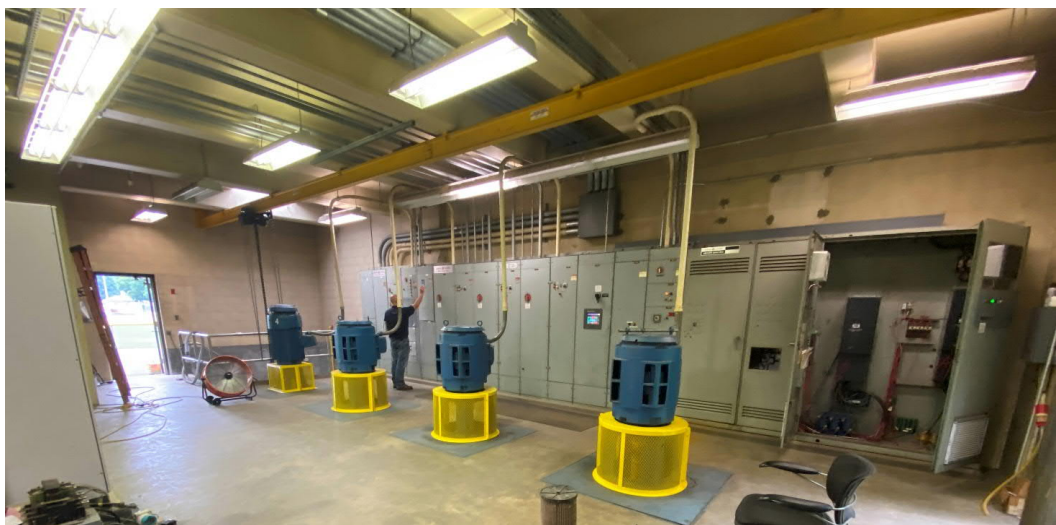

Main Street Pump Station Evaluation

- ❑ Full station evaluation conducted by Wright-Pierce in 2023
 - Bypass system to be installed as result of evaluation (to be constructed 2024-2025)
 - Service transformer purchased and to be installed
 - Generator to be replaced and relocated
- ❑ 3 of the 4 pumps are currently past their useful life expectancy of 20 years
- ❑ Ventilation is not adequate causes electrical controls to overheat (dry well) and creates a corrosive environment (wet well)
- ❑ Replacement of electrical and instrumentation components
- ❑ Structural repairs within the wet well due to corrosive environment

Stony Brook Pump Station Evaluation

- Pumps and associated piping and valves replaced in 2008
- Most equipment is currently within its design life
 - Equipment life expectancy will be reached within the planning period of the CWMP
- The pump station roof is damaged and leaking
- Pump runtime data indicates that wet weather has a strong influence on flow to this station

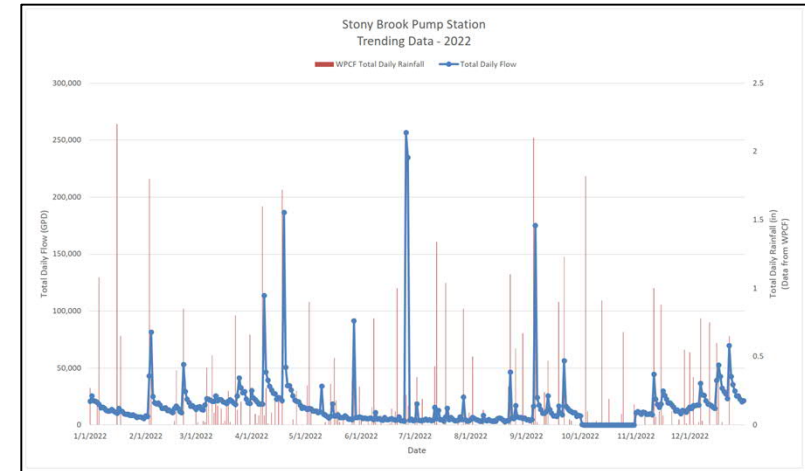

Morgan Street Pump Station Evaluation

- ❑ Pump station constructed in 1991
- ❑ Mechanical equipment (pumps and generator) and electrical equipment (with exception to the generator automatic transfer switch (ATS)) are original to the station and past their useful life expectancy
- ❑ Station receives a portion of Granby's wastewater flow
 - No planned sewer expansion within CWMP planning period
- ❑ Limited vehicle access to the station and equipment
- ❑ Town has expressed interest in converting this station to a submersible station

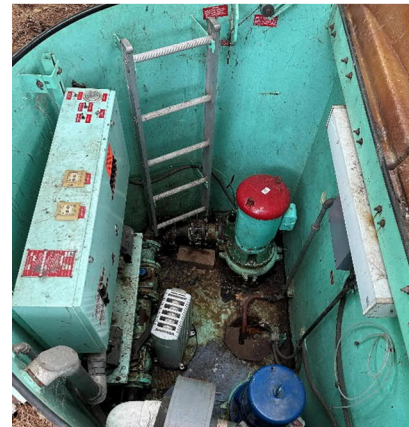

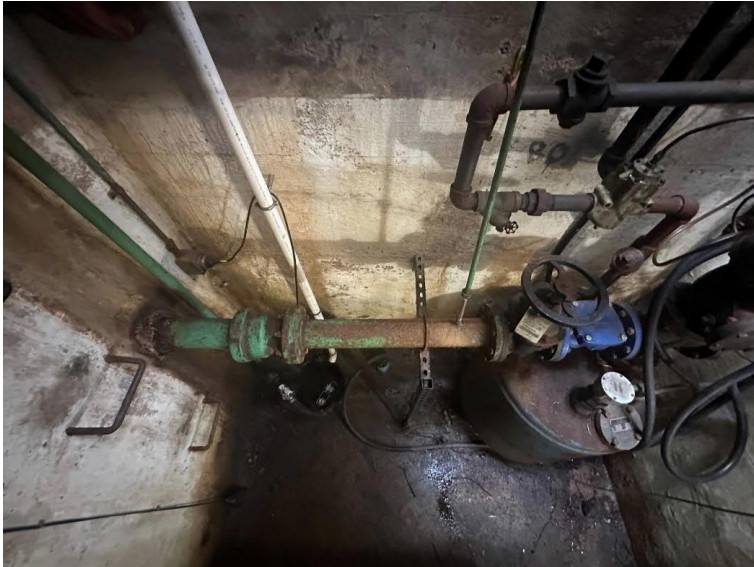

Old Sycamore Pump Station Evaluation

- ❑ Town's oldest pump station constructed in the 1960s
- ❑ Mechanical and electrical equipment are older than 30 years and have exceeded their design life
 - Compressor/pumps and valving require constant repair
- ❑ Equipment in the station is located below grade making it an explosion proof environment
 - Non-explosion proof electrical equipment is installed within this space (excluding main circuit breaker, compressor control panel, and light switches)
- ❑ We are looking at options to eliminate this station and diverting flows to the Topors Station
 - Overflows are presently directed to the to Topors Station when station is offline

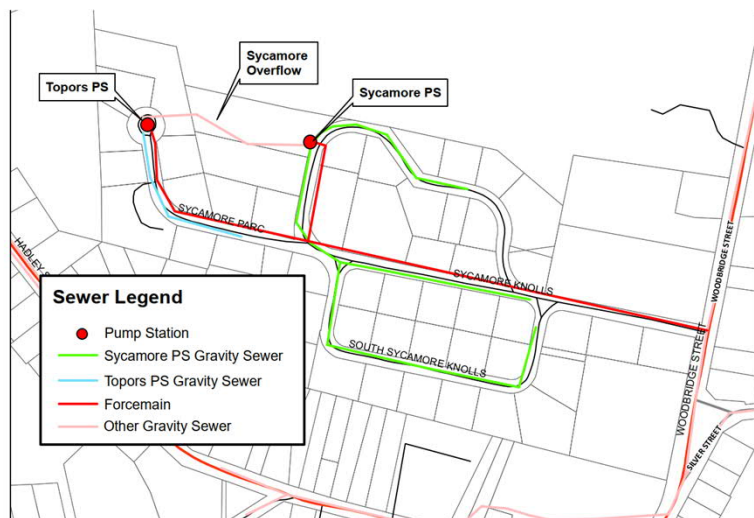



Topors Pump Station Evaluation

- ❑ Station was constructed in the 1970s
- ❑ Currently services only 10-15 properties
- ❑ Mechanical and electrical equipment has surpassed its design life
- ❑ Replacement parts for the generator are no longer readily available
- ❑ Confined space entry
- ❑ Elimination of Old Sycamore would require further capacity analysis of Topors

Wastewater Treatment Facility Evaluation

- ❑ Plant was originally constructed in 1975
- ❑ Upgrades were made in 2009
 - Replaced some aging equipment
 - No major process improvements
- ❑ Average Day Design Capacity – 4.2 mgd
 - Current average daily flow – 2.5 to 3.2 mgd (seasonal variations)
- ❑ Due to impacts from infiltration and inflow, influent pollutant concentrations are low.
 - Example: Influent BOD Concentration= 170 mg/l
Typical Influent concentration= 250 mg/l

Key Process Areas

Biological Treatment (Aeration System)

- ❑ Aeration system originally designed for BOD removal only (Conventional Treatment)
 - Four aeration basins equipped with 50 HP Surface Aerators
- ❑ Recent NPDES permit requires nitrogen removal to 350 pounds per day
 - Plant has trouble meeting the limit
 - To remove nitrogen ammonia first needs to be converted to nitrates
 - Nearly doubles the amount of oxygen required for treatment
 - The only process modification made to date:
 - Increase one of the surface aerators to 75 HP

Biological Treatment- Cont.

- ❑ Treatment process needs to be reconfigured to promote nitrogen removal
 - Most common means at your permit level is the MLE process
 - Requires the establishment of an anoxic zone
 - Reduces aerobic capacity

Conventional Activated
Sludge Process

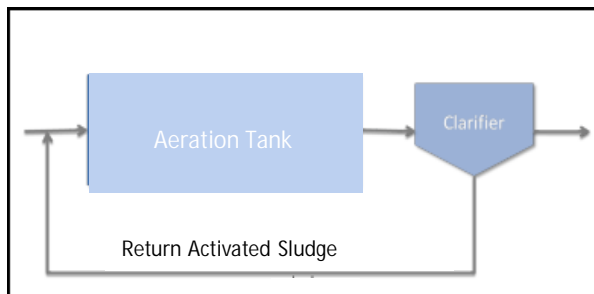

MLE Process

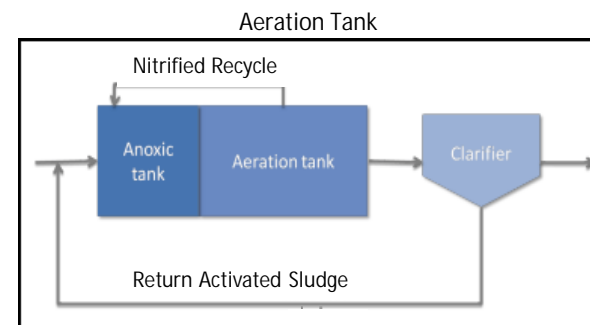

Disinfection

- ❑ Limits for E. Coli (126 col/100ml) and Chlorine Residual (1 mg/l)
- ❑ Trouble meeting both limits at the same time
 - Have to limit chlorine dose so effluent complies with permit
 - Chlorine dose may not be high enough to meet the bacteria limit
- ❑ Need to consider a dechlorination system

Equipment Nearing the End of it's Life Expectancy



Gravity Bucket Elevator



Primary Clarifier Sludge Collectors



Primary Sludge Pumps

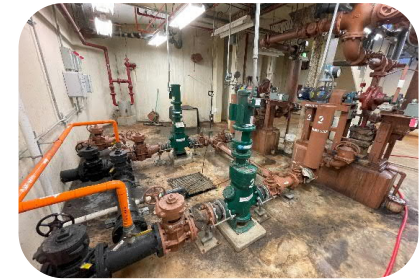

Primary Scum Pumps



Mechanical Surface Aerators



Return/Waste Activated Sludge & Scum Pumps



Gravity Thickeners and Sludge Collectors



Polymer and Dewatering Equipment



Heating Ventilation and Air Conditioning Systems

❑ Heating

- Electric unit heaters provide heat to most process buildings
- The Operations Building uses gas-fired hot water boilers
- All heating equipment appears to be beyond their design life

❑ Cooling

- Operations Building only
- Rooftop AC unit with an indoor air handler serves administration spaces

❑ Ventilation

- Most process buildings do not have operative ventilation for Class I Division 2 areas
 - Flammable gases are present
- Existing roof mounted exhaust fans show signs of corrosion and are over 45 years old
 - Sludge Pumping Building
 - Grit Building
- The Operations Building is ventilated through the AC unit

Electrical Systems Evaluation



- ❑ Site
 - Generator is beyond its design life (to be replaced in near future)
- ❑ Process Buildings (Grit, Digester, & RAS Pumping)
 - Power distribution equipment and electrical equipment are beyond their design life
 - Power distribution equipment and electrical components and motors are not in compliance with Class I Div. 2 area.
 - Lower level of Digester and Grit Building
 - Buildings do not have a fire alarm system or illuminated exit signs/exterior emergency lighting
- ❑ Operations Building
 - Power distribution equipment and electrical equipment are beyond their design life

Questions?

Comprehensive Wastewater Management Plan

South Hadley, MA
Selectboard Meeting

January 6, 2026



What is a Comprehensive Wastewater Management Plan (CWMP)?

- ❑ 20-year planning document that evaluates current and future Town-wide wastewater management needs
 - Considerations:
 - Need for sewer extensions to areas served by problematic on-lot systems
 - Necessary collection system improvements including pump stations
 - Improvements needed at the WWTP to meet permit limits and maintain reliable treatment
 - Qualify for Federal or State funding - projects have to be recommended in a CWMP

- ❑ Project was completed in three phases
 - Needs Analysis
 - Evaluation of alternatives to address identified need
 - Assessment of Environmental Impacts of the recommended plan

Wastewater Collection System

Wastewater Collection System

□ Service Area

- Over 95% of South Hadley residents
- A small section in north Chicopee
 - up to 150,000 gpd by agreement
- A small area in Granby
 - up to 85,000 gpd by agreement)

□ Components

- 85 Miles of sewer
- 5 Pump stations

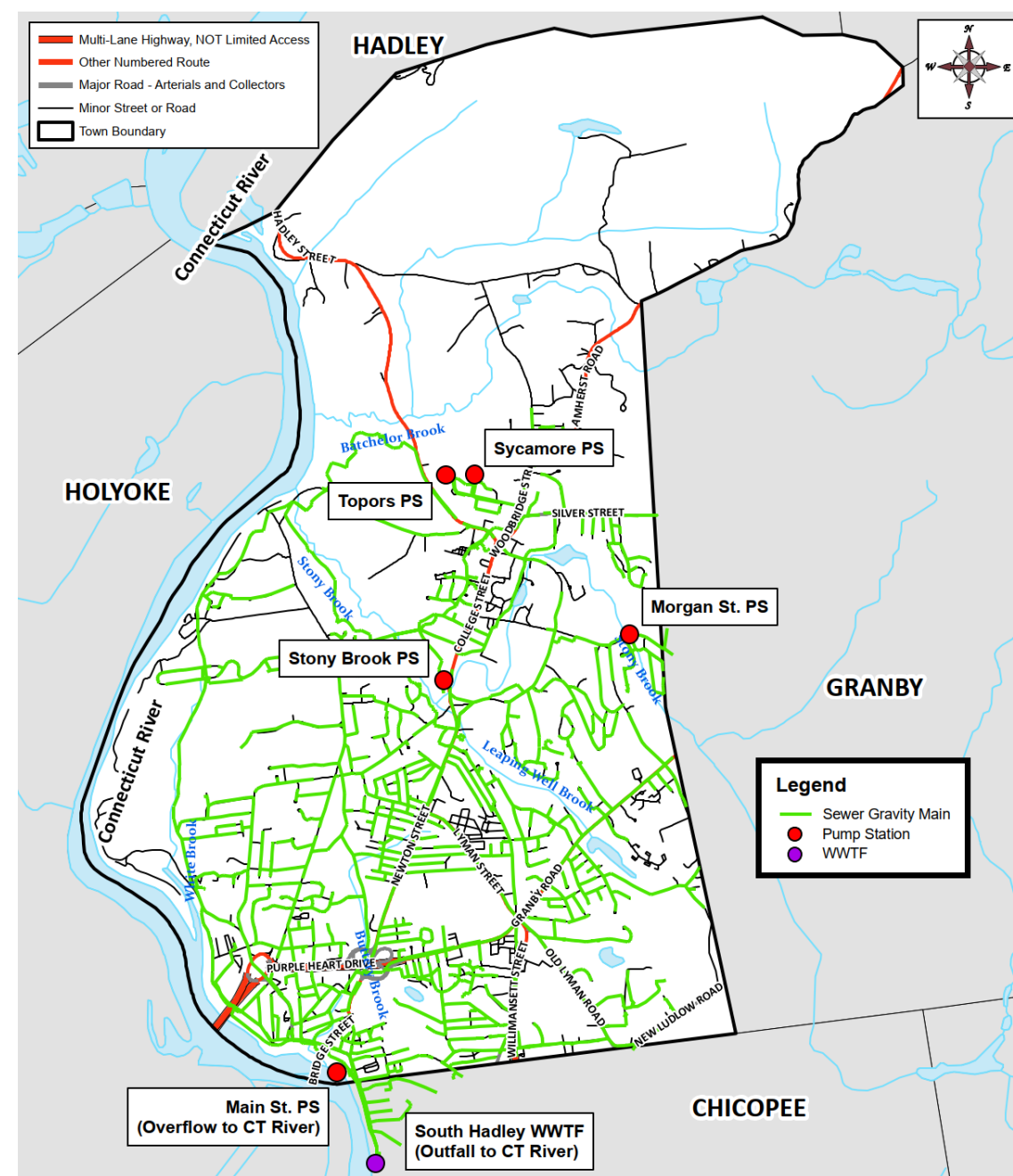

Infiltration and Inflow (I/I) Reduction

- ❑ Many of the town sewers were constructed between 1920 and 1950
- ❑ Originally constructed as a combined system (wastewater and stormwater) with 16 CSOs
- ❑ Town has expended considerable resources to eliminate the CSOs
 - Separated the wastewater and stormwater systems
 - Performed numerous repair projects to remove sources of infiltration and inflow.
 - Most recent project – Rehabilitation of the Judd Brook Interceptor

<u>2022 Flow Data (Pre-Rehabilitation)</u>			
<u>Sewershed</u>	<u>Location</u>	<u>Average Flow (mgd)</u>	<u>Peak Flow (MG)</u>
Judd-1	MH-1600	0.62	2.17
Judd-3	MH-1095	0.32	0.97

<u>2024 Flow Data (Post-Rehabilitation)</u>			
<u>Sewershed</u>	<u>Location</u>	<u>Average Flow (mgd)</u>	<u>Peak Flow (MG)</u>
Judd-1	MH-1600	0.59	1.85
Judd-3	MH-1095	0.11	0.31

- ❑ Town must continue to perform annual Flow Monitoring Studies to identify sources of I/I within the sewer system

Possible Collection System Expansion

- ❑ Six areas with problematic on-lot systems – approximately 130 homes (originally identified in 2001 CWMP but never sewered)
 1. Hadley Street (north of Bachelor Brook)
 2. Pearl Street
 3. Amherst Road area
 4. East Street
 5. Cove Island & River Road
 6. Meadow Lane, Woodbridge Road, Woodbridge Terrace, and Red Ledge Road
- ❑ Limitations such as ledge, high groundwater table, and soils with poor drainage
- ❑ Existing conditions require low pressure sewer extensions
 - Equates to approximately \$50,000 per home - Not cost effective

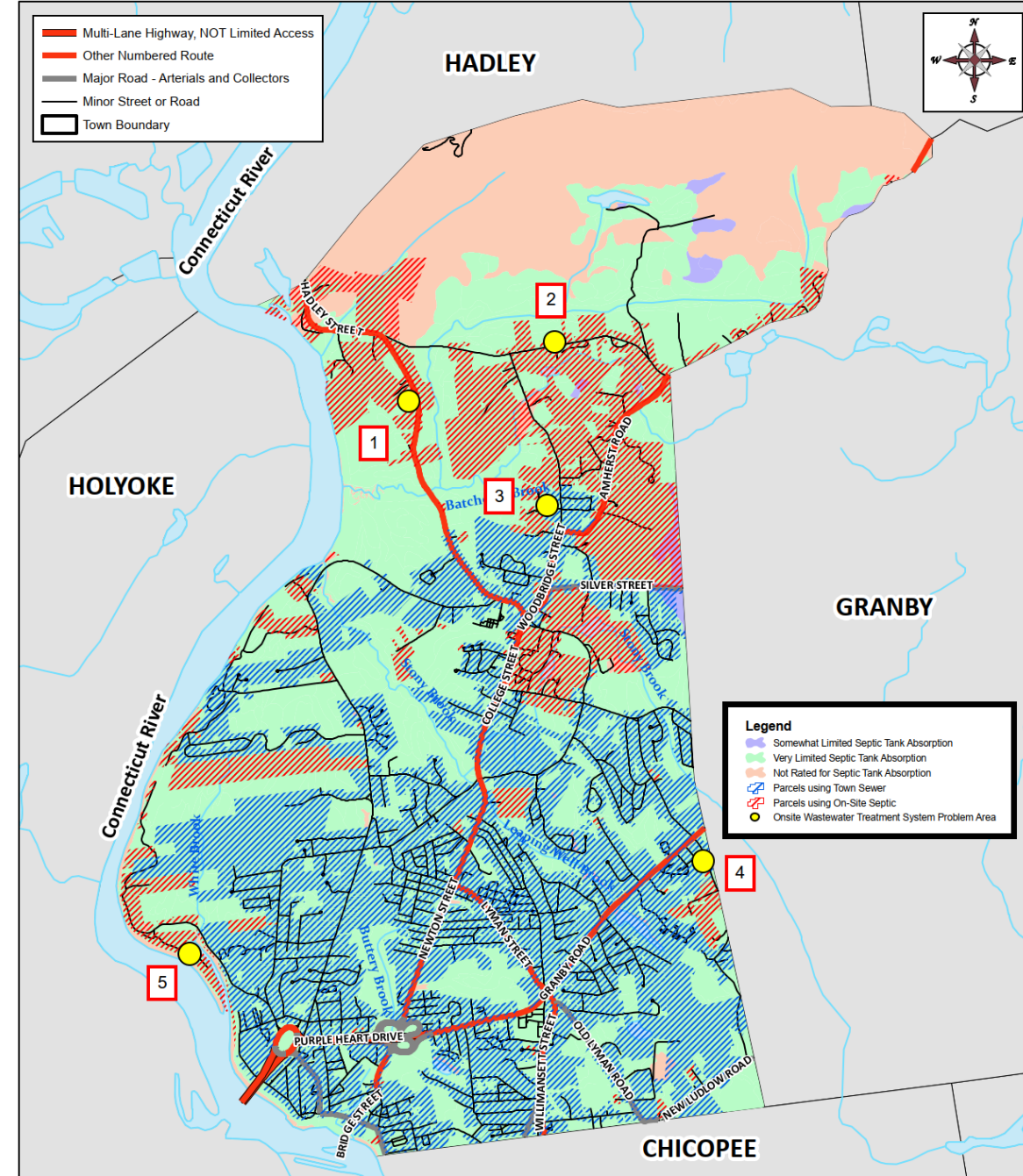

Wastewater Pump Station Evaluation

- ❑ Main Street Pump Station
 - Wet/Dry well Station (dry pit pumps)
- ❑ Stony Brook Pump Station
 - Converted from a pneumatic ejector station to a submersible station in 2008
- ❑ Morgan Street Pump Station
 - Suction Lift Station
- ❑ Old Sycamore Pump Station
 - Pneumatic Ejector Station
- ❑ Topors Pump Station
 - Pneumatic Ejector Station

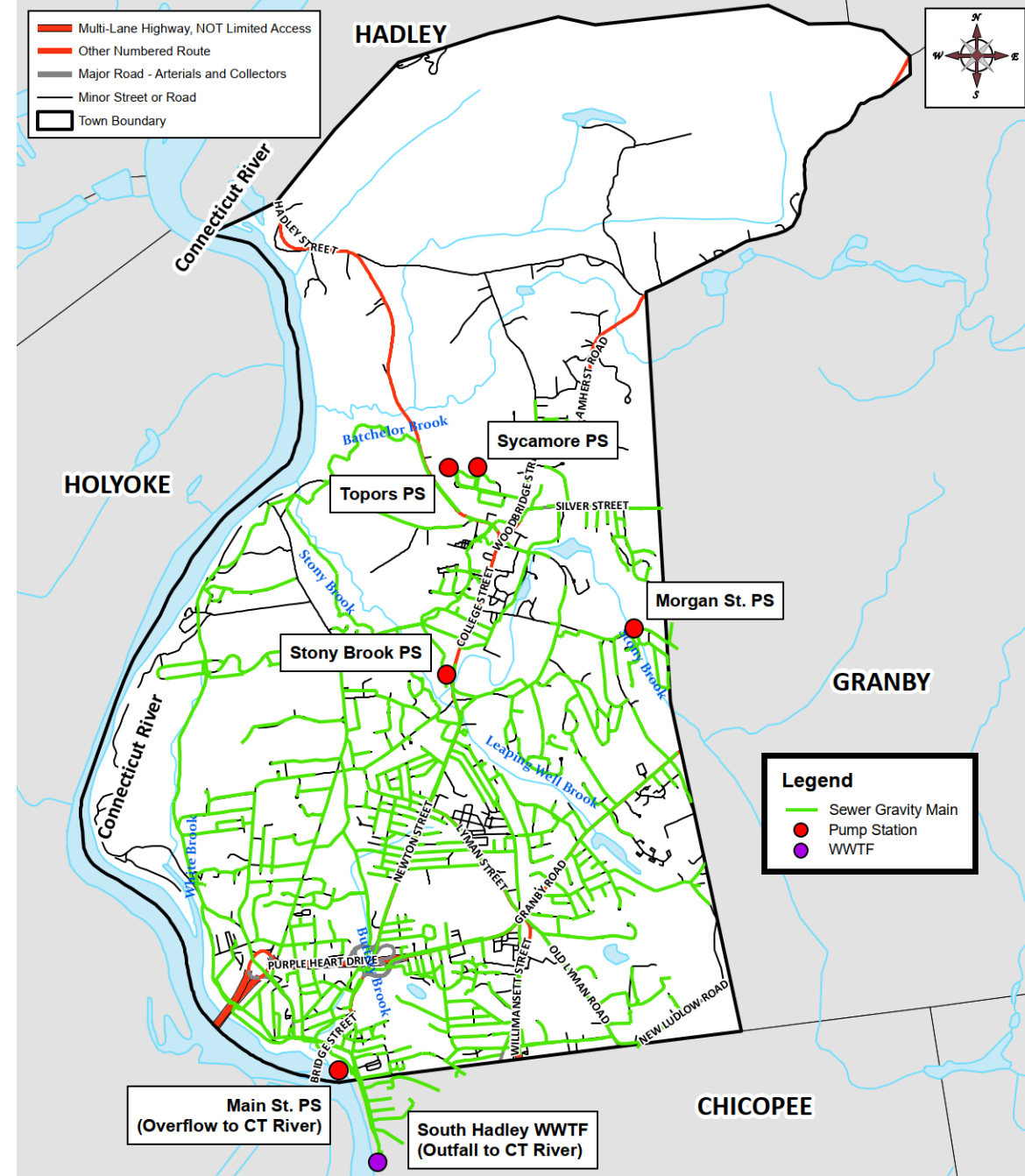



Main Street Pump Station Evaluation

- ❑ Key component in the Collection System
 - Conveys all wastewater to the treatment facility
- ❑ Full station evaluation conducted by Wright-Pierce in 2023
 - Emergency bypass system installed as result of evaluation
 - Generator replaced and relocated
 - Service transformer purchased and to be installed
- ❑ 3 of the 4 pumps are currently past their useful life expectancy of 20 years
- ❑ Ventilation is not adequate causes electrical controls to overheat (dry well) and creates a corrosive environment (wet well)
- ❑ Replacement of electrical and instrumentation components
- ❑ Structural repairs within the wet well due to corrosive environment
- ❑ **Opinion of Probable Project Cost: \$9,500,000**

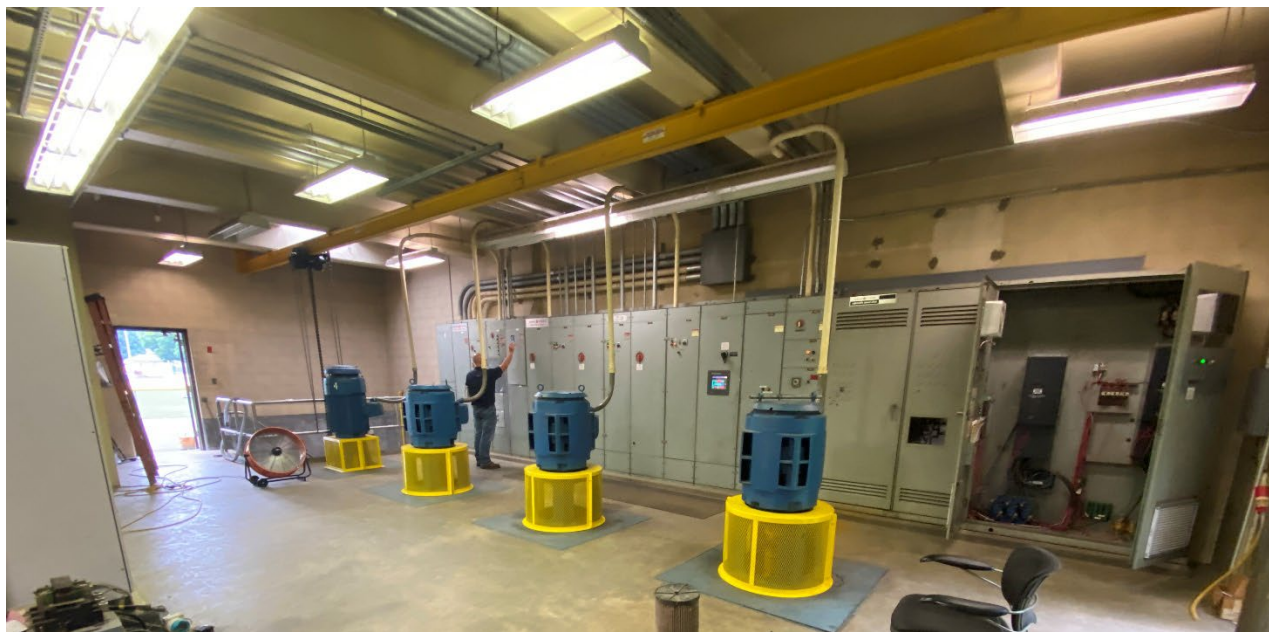

Stony Brook Pump Station Evaluation

- ❑ Pumps and associated piping and valves replaced in 2008
- ❑ Most equipment is currently within its design life
 - Equipment life expectancy will be reached within the planning period of the CWMP
- ❑ Recommended Immediate Improvements
 - Replace the pump station roof, which is damaged and leaking
 - Replace the hot water heater



Morgan Street Pump Station Evaluation

- ❑ Suction Lift pump station constructed in 1991
- ❑ Majority of mechanical and electrical equipment are original to the station and past their useful life expectancy
- ❑ Recommended Improvements
 - Convert station to a submersible pump station
 - Improve site access to allow for pump trucks and large equipment
 - Replace and relocate emergency generator
 - Replace HVAC equipment



Old Sycamore Pump Station Evaluation

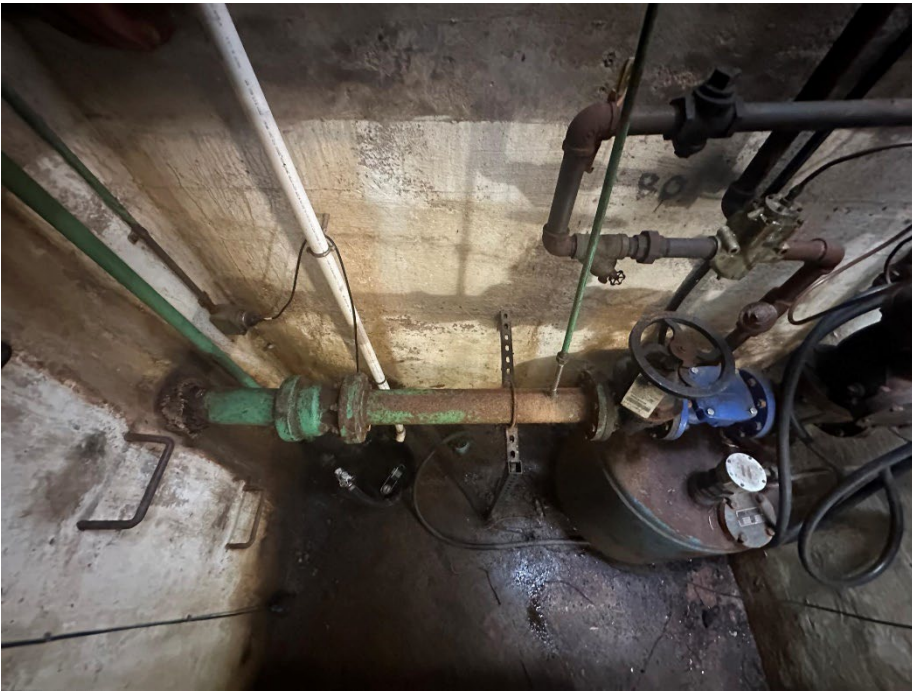

- ❑ Town's oldest pump station constructed in the 1960s
- ❑ Mechanical and electrical equipment are older than 30 years and have exceeded their design life
- ❑ Recommended Improvements
 - Abandon station and redirect flows to Topors Pump Station
 - Requires removal of existing equipment, filling the existing chamber, and rehabilitating the existing overflow pipe to Topors station

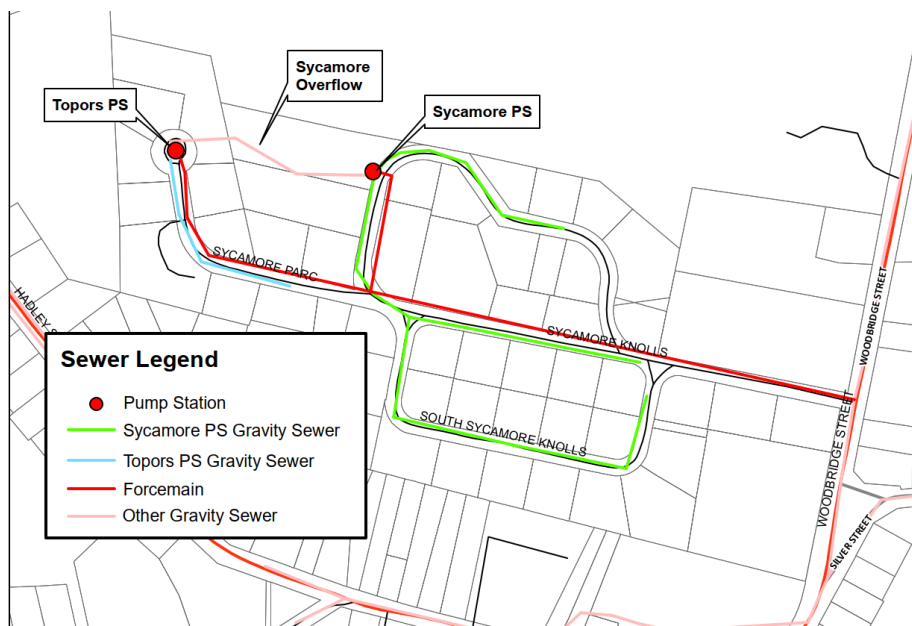



Topors Pump Station Evaluation

- ❑ Pneumatic Ejector station was constructed in 1973
- ❑ Currently services only 10-15 properties
- ❑ Mechanical and electrical equipment has surpassed its design life
- ❑ Recommended Improvements
 - Upgrade station to a submersible station
 - Increase capacity to handle flow from Old Sycamore
 - Replace emergency generator and ATS

Wastewater Treatment Plant

Wastewater Treatment Plant

- ❑ Originally constructed in 1960 with primary pretreatment and anaerobic digestion of biosolids

- ❑ Secondary treatment using a conventional activated sludge process was added in the late 1970s

- ❑ Limited upgrades completed in 2008
 - Replacement of the mechanical surface aerators and other equipment
 - Installation of activated carbon for odor control

- ❑ Due to the age of the facility, much of the existing equipment and support systems are operating beyond their design lives.
 - Upgrades are necessary to ensure the long-term reliability of treatment processes.

Wastewater Treatment Plant - Flow

❑ Design Flow Rate

- Average Daily Flow: 4.2 mgd
- Peak Hourly Flow: 10.7 mgd

❑ Current Flow:

- 3.05 mgd - 12-month rolling average flow (January 2021 – December 2024)
- 8 mgd – Routine Wet Weather flow – inflow impacts remain in the collection system

❑ Projected Flow: 3.3 mgd

- Very limited sewer expansion in South Hadley, Granby and Chicopee
- Granby and Chicopee - no interest higher flow allocations

Wastewater Treatment Plant – Permit Compliance

❑ Discharge limits that are not consistently achieved:

- Total Nitrogen: 350 pounds per day (12-month rolling average)
 - WWTP does not have a process designed for nitrogen removal

- E.coli: 126 colonies per 100 ml or 1 mg/l chlorine residual
 - Balance between the dose of NaOCl to kill bacteria and the Chlorine residual concentration in the discharge.
 - Difficulty meeting both limits simultaneously

Recommended Plan – Nitrogen Removal

- ❑ Convert the conventional activated sludge process to the MLE process
 - Conversion of the first basin in each treatment train to a dedicated anoxic zone (no air).
 - Installation of submersible mixers in each pass of the anoxic zone and in the swing zone;
 - Installation of a fine bubble diffusers in the swing zone and the dedicated aerobic basin;
 - Construction of a new enclosure to house blowers and associated electrical controls,
 - Installation of two internal recycle pumps at the end of each aerobic basin.

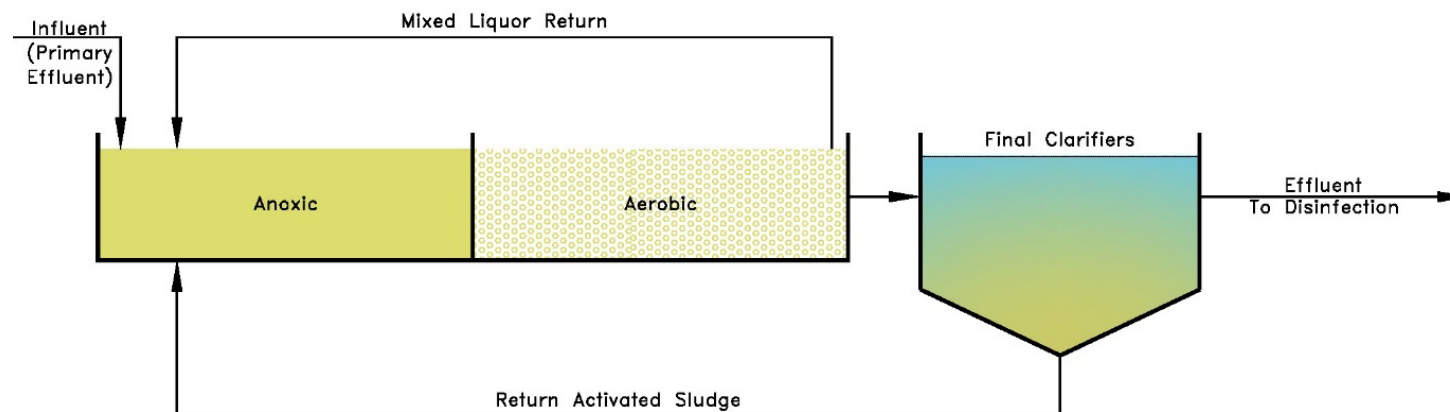

Recommended Plan – Disinfection Improvements

- ❑ Implement dechlorination into disinfection system
 - Provisions to add sodium bisulfite prior to the discharge to reduce chlorine residual
 - Allows for higher NaOCl dose to kill bacteria
- ❑ Required improvements
 - Construction of a prefabricated, heated building to house bisulfite storage containers
 - Installation of pumps to meter bisulfite into the discharge end of the chlorine contact tanks
 - Instrumentation to monitor chlorine residual and adjust the dose of bisulfite.

Other Facility Improvements

- ❑ Grit Removal Equipment - Been in operation for over 40 years
 - The bucket elevator, grit screw conveyor, and the dewatering screw need to be replaced.

- ❑ Primary Clarification – Equipment last replaced in 1998
 - Replace chain and flight sludge collectors
 - Replace primary sludge pumps.
 - Separate the drives for clarifiers #2 and #3 improve redundancy.



Grit Bucket Elevator



Primary Sludge Collectors



Primary Sludge Pumps

Other Facility Improvements

- ❑ Replacement of the secondary clarifier drives, rake arms, and sludge draw-off equipment
 - Installed in the late 1970s.
- ❑ Replacement of the two steel gravity thickeners in the solids handling process.
 - Installed in the late 1970s
 - Exhibiting signs of corrosion due to the harsh environment
 - New gravity thickeners should be covered for odor control
- ❑ Replacement of the two thickened sludge pumps
- ❑ Replacement of single belt filter press (installed in 1990) with two centrifuges.
 - Two units are suggested for process redundancy.
- ❑ Replace HVAC and air handling system solids handling area

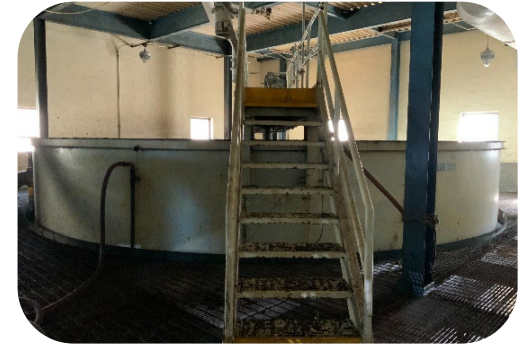

Gravity Thickeners



Belt Filter Press

Other Facility Improvements

- ❑ New Odor Control Scrubber
- ❑ Replacement of most of the electrical systems.
- ❑ Replacement of HVAC systems throughout the plant.
- ❑ Replacement of the SCADA control system
 - Presently configured with two separate PLC platforms without redundant PLC processors
 - No longer supported by the manufacturer.
- ❑ The buildings at the WWTF were constructed in the late 1970s.
 - Replace windows, doors, and roofs
 - Reconfigure and refresh the administrative offices
 - Update bathrooms and locker rooms



Typical Electrical Panel

Opinion of Probable Project Costs

Wastewater Treatment Plant Improvements

Total Project Cost	\$ 37,360,000
Principal Forgiveness	\$ 2,300,000
Net Project Cost	\$ 35,060,000
Annualized Net Project Cost (0%)	\$ 1,810,000

Cost Allocation per EDU: \$206

Pump Station Improvements

Total Project Cost	\$ 13,010,000
Principal Forgiveness	\$ 800,000
Net Project Cost	\$ 12,210,000
Annualized Net Project Cost (2%)	\$ 760,000

Cost Allocation per EDU: \$86

Note: Total Number of EDUs Billed = 8,858

Financing Options

- ❑ Funding available through Clean Water SRF program through MassDEP
 - Construction funded at 2% interest loan over 20-year term
 - Opportunity for 0% interest loan (for nitrogen removal project)
 - Eligible for 6.6% principal forgiveness for Disadvantaged Communities
 - Tier 1: APCI more than 80% but less than 100% of the State's APCI = 3.3%
 - **Tier 2: APCI more than 60% but less than 80% of the State's APCI = 6.6%**
 - Tier 3: APCI less than 60% of the State's APCI = 9.9%

South Hadley APCI = 63.2%

Acknowledgements

- ❑ John Broderick, Director of Public Works

- ❑ Melissa LaBonte, Superintendent of Water Pollution Control
 - ❖ All the staff at the Wastewater Treatment Plant

Questions?



Steven Richtarik, PE
401-333-2382
srichtarik@beta-inc.com



Alan Gunnison, PE
401-333-2382
agunnison@beta-inc.com



Peter Natowich, PE
860-513-1503
pnatowich@beta-inc.com

GOLF OPERATIONS REPORT

Fall 2025



International Golf Maintenance
5385 Gateway Blvd. Suite 12
Lakeland, FL 33811
P: 800-413-5500
golfmaintenance.com



General Comments

The 2025 golf season began with untimely rainfall in the spring and ended with below average temperatures in November. Inclement weather can negatively impact usage and revenue greatly. Regardless of the weather challenges at the beginning and end of the season, revenue for the 2025 golf season (Jan – Dec 12th \$1.728M) was very similar to the 2024 totals (\$1.729M) when we had better than average weather. Considering the challenges, the season was a success.

The season began with losing twelve weekend days due to precipitation. These days are the most profitable for most golf operations. Weather impacted November's results significantly due to a lower average daytime high temperature of 49 degrees versus 56 degrees in 2024. In addition, frost delays were more frequent in November of 2025 impacting nearly 55% of morning tee times offered during the month. Had the weather cooperated in November alone and matched the month of November of 2024, revenue would have surpassed \$1.75M.

Customer service continued to be offered at a high-level with a significant number of rave reviews being reported about our new Golf Professional, Ed Lockard. Ed made an enormous impact on the operation!

In addition to a spectacular first season with our new Golf Professional, our Superintendent, Amanda Fontaine continued to impact the golf industry bringing notoriety and acclaim to The Ledges' operation. Amanda presented Turf Winter Kill study findings at the New England Turf Conference and contributed to the "Wonderful Women of Golf" campaign in their industry podcast, ABC 5 Chronicle article, Golf Course Industry Magazine and in Golf Digest features.

The Course won the Gazette Reader's Choice Awards for Best Local's Golf Course and Best Driving Range, the course was rated #6 in Massachusetts by Golf Pass, and player ratings on Golf Pass are holding steady at 4.6 stars. Feedback indicated that the course "value" is still Excellent, but our "pace of play" continues to be an area where we could improve. Much of the discussion from the recent operational review revolved around increasing rounds. However, we must be mindful that if we increase rounds, it could have a negative impact on pace of play and subsequently player satisfaction. Since "value" is still rated as Excellent, we see opportunity in increasing rates during certain times and certain days to drive further revenue growth, i.e. Friday, Saturday and Sunday mornings during season. This will protect course conditions and player satisfaction.

FY26 was trending better than Jul – Oct in FY25, but the relatively slow November caused a slight dip in the numbers. A strong membership drive has allowed us to recapture some of the lost revenue from a poor weather November. Overall, FY26 has started identical to FY25 with total sales of \$1.045M (Jul – Dec).

2026 marks the 25th anniversary of Ledges Golf Club celebrating a quarter century of unforgettable rounds, lasting friendships, and a shared love of the game. Since opening its fairways 25 years ago, the course has become known as one of the area's finest tests of golf while maintaining extraordinary playing conditions. Exciting club events will take shape as we honor this remarkable milestone that will be celebrated by our members, golfing patrons and the South Hadley community.



2025 Events and Charities Benefited

- USGA Junior Amateur Qualifier
- South Hadley High School Golf Team*
- UMASS Police
- Holyoke Regional YMCA
- South Hadley / Granby Chamber
- East of the River Five
- Human to Human
- Luke Stronger
- UMASS Football
- South Hadley Food Pantry
- Galaxy Community Council
- Worcester County Seniors
- Glow Ball
- Numerous leagues and smaller events

*228 rounds and 55 bags of range balls were donated to South Hadley High School

2025 Operational and Course Accomplishments

- New golf carts
- New range mats
- Took delivery of two new rough mowers and a large fairway and rough blower
- Paved cart paths on holes 2, 4, 9 and leading to the bridge
- Replaced tee sprinklers on 1-9, 10, 11, 17 and 18
- Repaired numerous irrigation control wires
- Removed rock shelf in 18 fairway
- Resodded 3 green's collar
- Installed new drainage on hole 2

2026 Goals

- Install automated range ball dispenser
- Host week long Junior's Camp in cooperation with the South Hadley Recreation Department
- Host Member-Member and Member-Guest event
- Hold a season opener member's only event
- Enhance service with a dedicated Greeter in front of the Clubhouse on Friday, Saturday and Sunday mornings
- Host USGA / UMASS / First Green event for industry education and community outreach

2026 Proposed Rate Structure

Daily Fees

Weekday (Mon - Thu) - 18 holes	2025		2026	
	Walking	Riding	Walking	Riding
Resident	\$ 38	\$ 58	\$ 38	\$ 58
Senior Resident (62+)	\$ 32	\$ 52	\$ 32	\$ 52
Non-Resident	\$ 40	\$ 60	\$ 42	\$ 64
Non-Resident (62+)	\$ 33	\$ 53	\$ 35	\$ 55
Military & Student (With ID)	\$ 30	\$ 50	\$ 35	\$ 55
Junior (13-17)	\$ 15	\$ 25	\$ 15	\$ 25
Junior (12 and under)	\$ 10	\$ 25	\$ 10	\$ 25

Weekend (Fri - Sun) - 18 holes	2025		2026	
	Walking	Riding	Walking	Riding
Non-Resident	\$ 50	\$ 70	\$ 55	\$ 75
Non-Resident (1pm-4pm)	\$ 44	\$ 64	\$ 46	\$ 66
Resident			\$ 50	\$ 70
Resident (1pm-4pm)	\$ 44	\$ 64	\$ 44	\$ 64
Twilight (4pm-5:30pm)	\$ 38	\$ 50	\$ 40	\$ 52
Military, Senior & Student (After 1pm with ID)	\$ 35	\$ 56	\$ 37	\$ 58
Junior (After 1pm, 13-17)	\$ 15	\$ 25	\$ 15	\$ 25
Junior (12 and under with paying adult, after 3pm)	\$ 10	\$ 30	\$ 10	\$ 30

Weekday (Mon - Thu) - 9 holes	2025		2026	
	Walking	Riding	Walking	Riding
Resident	\$ 30	\$ 42	\$ 32	\$ 42
Non-Resident	\$ 32	\$ 43	\$ 34	\$ 45
Junior (13-17)	\$ 15	\$ 26	\$ 17	\$ 28
Junior (12 and under with paying adult)	\$ 10	\$ 22	\$ 10	\$ 22

Weekend (Fri - Sun) - 9 holes after 1pm	2025		2026	
	Walking	Riding	Walking	Riding
Resident	\$ 33	\$ 45	\$ 33	\$ 45
Non-Resident	\$ 35	\$ 46	\$ 37	\$ 48
Junior (13-17)	\$ 15	\$ 27	\$ 15	\$ 27
Junior (12 and under with paying adult)	\$ 10	\$ 25	\$ 10	\$ 25

Season Passes

7 Day	2025	2026
Family	\$ 2,700	\$ 2,800
Single	\$ 2,000	\$ 2,100
Senior Single (62+)	\$ 1,800	\$ 1,900
Senior Family (62+ both members)	\$ 2,475	\$ 2,550
Twilight (after 1pm)	\$ 1,550	\$ 1,625
Young Professional (23 - 29)	\$ 1,600	\$ 1,700
Student (18 - 22, Weekends/Holidays after 1pm)	\$ 900	\$ 900
Junior (17 and under)	\$ 450	\$ 450

Weekday (Mon - Fri)	2025	2026
Single	\$ 1,700	\$ 1,800
Single Senior (62+)	\$ 1,650	\$ 1,750
Senior, Family (62+ both members)	\$ 2,050	\$ 2,100
Twilight (after 1pm)	\$ 1,275	\$ 1,350

Cart Plans (Includes Tax)	2025	2026
Single	\$ 1,250	\$ 1,300
Single, Weekday or Twilight	\$ 950	\$ 1,000
Additional Family Plan	\$ 400	\$ 400

Driving Range (NEW)	2025	2026
Single		\$ 600

The Ledges Golf Club

Projections

	<u>FY 2022</u> Actual Revenue	<u>FY 2023</u> Actual Revenue	<u>FY 2024</u> Actual Revenue	<u>FY 2025</u> Actual Revenue	<u>FY 2026</u> Projection	<u>FY 2027</u> Projection	<u>FY 2028</u> Projection	<u>FY 2029</u> Projection
Revenues:								
Greens Fee's / Cart Rentals	\$ 1,033,519	\$ 1,152,015	\$ 1,196,427	\$ 1,338,261	\$ 1,378,408	\$ 1,419,761	\$ 1,462,353	\$ 1,506,224
Pro Shop	\$ 49,825	\$ 67,005	\$ 59,218	\$ 57,526	\$ 59,252	\$ 61,029	\$ 62,860	\$ 64,746
Misc./ Lessons	\$ 47,232	\$ 6,603	\$ -	\$ -	\$ -	\$ -	\$ -	\$ -
Food & Beverage	\$ 292,960	\$ 369,657	\$ 346,989	\$ 333,526	\$ 343,532	\$ 353,838	\$ 364,453	\$ 375,387
Total Revenues	\$ 1,423,536	\$ 1,595,280	\$ 1,602,634	\$ 1,729,313	\$ 1,781,192	\$ 1,834,628	\$ 1,889,667	\$ 1,946,357
Operating Expenses:								
Management Fee	\$ 36,000	\$ 36,000	\$ 39,900	\$ 39,900	\$ 39,900	\$ 39,900	\$ 39,900	\$ 39,900
Operations Expense	\$ 671,129	\$ 711,129	\$ 764,464	\$ 830,600	\$ 847,212	\$ 868,392	\$ 890,102	\$ 912,355
Maintenance Contract	\$ 571,932	\$ 612,229	\$ 625,239	\$ 701,762	\$ 715,797	\$ 733,692	\$ 752,034	\$ 770,835
Total Operating Expenses	\$ 1,279,061	\$ 1,359,358	\$ 1,429,603	\$ 1,572,262	\$ 1,602,909	\$ 1,641,984	\$ 1,682,037	\$ 1,723,090
Net Operating	\$ 144,475	\$ 235,922	\$ 173,031	\$ 157,051	\$ 178,283	\$ 192,643	\$ 207,630	\$ 223,267

MEMO

To: Selectboard
From: TA Lisa Wong
Re: Agriculture Bylaw
Date: 12/26/25

Background: Agricultural Uses Zoning Bylaw Amendments

Assessment report and draft bylaws online (posted January 2025):

www.southhadley.org/1318/ProposedDraft-Bylaws

An advisory committee has been formed by the Director of Planning and Conservation, and appointed by the Town Administrator, to review the draft zoning bylaw amendments. As discussed in late winter/early spring 2025, an advisory committee would be formed to explore the bylaw recommendations more in depth, and make any additional recommendations prior to the Planning Board taking this back up for discussion. The committee held their first meeting on 12/18/25, and anticipates meeting several more times before sending final bylaw recommendations to the Planning Board. Ideally, we would like to send this to Town Meeting for May 2025 which would require the Planning Board to begin public discussion and hearings in March.

Agricultural Uses Bylaw Amendments Advisory Committee

Name	Affiliation
Tina Smith	MDAR APR Stewardship Southern Berkshire & Hampshire County Division of Agricultural Conservation and Technical Assistance
Steve McCray	Farm Business Owner
Rebekah Cornell	Conservation Administrator/Tree Warden

Anne Capra

Director Planning & Conservation

Rob Watchilla

Planning Board Member

Sharon Hart

Director of Public Health

Chuck Scott

Board of Health Member

Tom Reidy

Resident

Mark Cavanaugh

Resident